

RENAULT MEGANE E-TECH

100% electric



2nd July 2024

UK spec may vary*



take to the road, electrically

With Renault Megane E-Tech 100% electric, pure driving pleasure and cutting-edge technology combine for an innovative mobility experience.



Model shown is techno with iconic version wheels. Combination unavailable for sale in the UK. Image shown for illustrative purposes only.

Bringing you such a great experience was simply a matter of pushing the boundaries. So that's what we did.

220 hp

**from 0 to
62 mph in 7.5 s**

**up to 285 miles
WLTP of range⁽¹⁾**

**openR link
system with
Google built-in⁽²⁾**

**440 litres of
boot volume**

**up to 24
advanced driver-
assistance
systems**

(1) 285 miles on the evolution version, in WLTP cycle, actual range depends on driving conditions (type of road, driving style and weather conditions). (2) Google, Google Maps, Google News, Waze and other marks are trademarks of Google LLC. Only available from techno version. *UK spec may vary. Combination of paint and wheels unavailable for sale in the UK. Image shown for illustrative purposes only. Please check online configurator via [renault.co.uk](https://www.renault.co.uk) to see paint availability by version.

interactive menu

01. design

02. driving range and charging

03. multimedia

04. interior space

05. advanced driver-assistance systems

06. customisation

PDF for download



equipment and engines



accessories

01. design

pure design

Sensual and sleek, the lines of the 100% electric Renault Megane E-Tech combine compactness with the liveliness of a sports car. Its original proportions and large 20" wheels⁽¹⁾ showcase its innovative personality.



Model shown is techno with iconic version wheels. Combination unavailable for sale in the UK. Image shown for illustrative purposes only.

It's all about style, with its flame red colour scheme combined with a diamond black roof, full LED front brand light and 3D moiré effect strip at the rear.



Model shown is techno with iconic version wheels. Combination unavailable for sale in the UK. Image shown for illustrative purposes only.



reinvented ergonomics

Geared to meet all the driver's needs, the new cockpit features one of the largest on-board digital surfaces ever developed for a car: openR over two 12" screens.⁽¹⁾

Grouped around the steering wheel, all the controls are easily accessible. The ergonomics are perfect, driving more serene.



UK dashboard fabric varies

(1) depending on version.

build yours →

02. driving range and charging

pure electric sensation

Acceleration is vigorous, linear and muscular: with the 220 hp engine, it takes just 7.5 seconds to go from 0 to 62 mph.

With its dynamic chassis and low centre of gravity, driving sensations are maximised. Renault Megane E-Tech 100% electric reveals its sporty DNA.



Model shown is techno with iconic version wheels. Combination unavailable for sale in the UK. Image shown for illustrative purposes only.

With paddles at your fingertips*, manage the four levels of regenerative braking: as soon as you decelerate, you recover energy.



all the vehicle's main controls are centralised around the steering wheel: driver-assistance systems, call management, voice recognition activation



customisable 12.3" screen that can be customised according to the driving mode: sport to increase power and responsiveness

* regenerative paddle shifters from techno version

02. driving range and charging

285 miles driving range⁽¹⁾

Renault Megane E-Tech 100% electric is the result of innovative research and development that pushes the limits of performance and efficiency: optimised weight distribution, a generous wheelbase, and an extremely low centre of gravity.



Model shown is techno with iconic version wheels. Combination unavailable for sale in the UK. Image shown for illustrative purposes only.

Its new platform houses an ultra-flat 60 kWh battery and a compact 160 kW electric engine for a WLTP range of up to 285 miles⁽¹⁾.

aerodynamic design

The lines of Renault Megane E-Tech 100% electric have been designed to maximise aerodynamics through the vehicle height and its autonomy: roof design, narrow-sided tyres, and sculpted bumpers.

heat pump and heat management

Renault Megane E-Tech 100% electric comes with a heat pump linked to a battery and engine heat-management system, which automatically regulates battery and engine temperature, and ensures the thermal comfort of the passenger compartment whatever the weather.

optimum weight

Weighing in at just 1,638 kg thanks to its aluminium doors, Renault Megane E-Tech 100% electric is one of the lightest electric vehicles in its category, meaning even greater driving range at equivalent power.

driving range⁽¹⁾

comfort range:
up to 285 miles

⁽¹⁾ in WLTP cycle, actual range depends on driving conditions (type of road, driving style and weather conditions) and up to 285 miles range Renault internal source / 2023.

02. driving range and charging

easy to charge

Renault Megane E-Tech 100% electric comes with a versatile range of charging options that is unique on the market: at home, at work or on the road.



Model shown is techno with iconic version wheels. Combination unavailable for sale in the UK. Image shown for illustrative purposes only.

charging at home, at work or elsewhere

AC 22 kW maximum charge

Charge Renault Megane E-Tech 100% electric easily at home⁽²⁾ using a wall-mounted charging point or a 3 pin socket. Outdoors, take advantage of the public network to charge the battery from 15-80% in just under 2 hours at 22 kW charging points.

My Renault application

Check your range at any time; start charging your vehicle remotely to start at off-peak times.

Mobilize power solutions

Order your charging solution and get it installed. Install a Mobilize charging point or a reinforced socket in your home to charge your vehicle with ease. Order your charging solution from the Renault network, and an expert will install it before your new Renault Megane is delivered.

motorway charging

DC rapid charge

For longer journeys, just over 30 minutes of charging at a rapid charging station will allow you to drive for 182 miles⁽³⁾.

My Renault application

Locate the public charging points closest to your destination.

Mobilize charge pass

Make charging on the road easier and pay less. Charge your Renault Megane quickly and easily on the move with a pass to Europe's largest charging network at attractive rates.

(1) standard on all versions. (2) Mobilize power solutions offering. For more information about Mobilize services, go to the Mobilize services page. (3) based on 36 minutes of rapid charge on up to 130kW DC charging in ambient conditions, recovering from 15-80%.

Renault Megane E-Tech 100% electric is delivered with a mode-3 type cable⁽¹⁾ that can be used with a domestic⁽²⁾ or a public charging station.

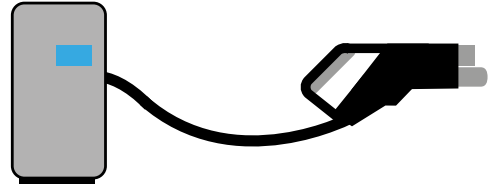
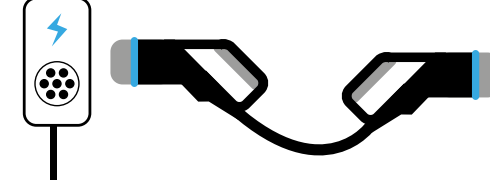
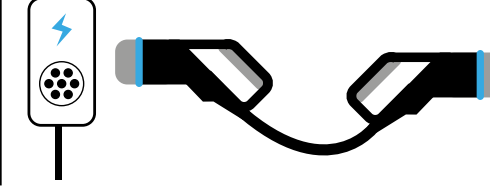
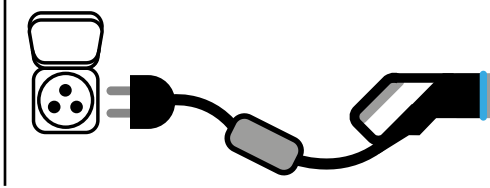
public		domestic	
public fast charging point⁽³⁾ 130 kW DC cable attached to station	public charging station 22 kW AC mode 3 cable included with purchase	domestic charging station⁽²⁾ 7.4 kW AC mode 3 single-phase cable included with purchase	standard 3-pin domestic socket 2.3 kW AC mode 2 cable flexi-charger as an accessory
			
comfort range 15 to 80% → 32 min	15 to 80% → 1 hr 50	15 to 80% → 6 hrs 01	15 to 80% → 19 hrs 48

simulate driving range and charging time

(1) mode 3 single-phase cable. (2) Mobilize power solutions offering. For more information about Mobilize services, go to the Mobilize services page. (3) maximum power and charging times are based on optimal charging conditions for the vehicle and for the charging point (peak power). The maximum power accepted by the battery (mainly in DC charging) varies depending on the battery's state of charge and the exterior temperature up to 130 kW for a comfort range battery.

build yours →

openR & openR link, next-generation interface

With the new dual 12" openR screen⁽¹⁾, marvel at one of the largest on-board digital surfaces.

For the best connected driving experience, Renault has integrated Google⁽¹⁾⁽²⁾ into the new smart openR link multimedia system⁽¹⁾. Up to 50 applications are available⁽¹⁾, including 11 from Renault partners with Google Play⁽³⁾.



8 colour schemes to choose from and a high-definition image with reduced glare and more colours

Simplify your electric journey with Google Maps⁽²⁾ and use a journey planner updated in real time.

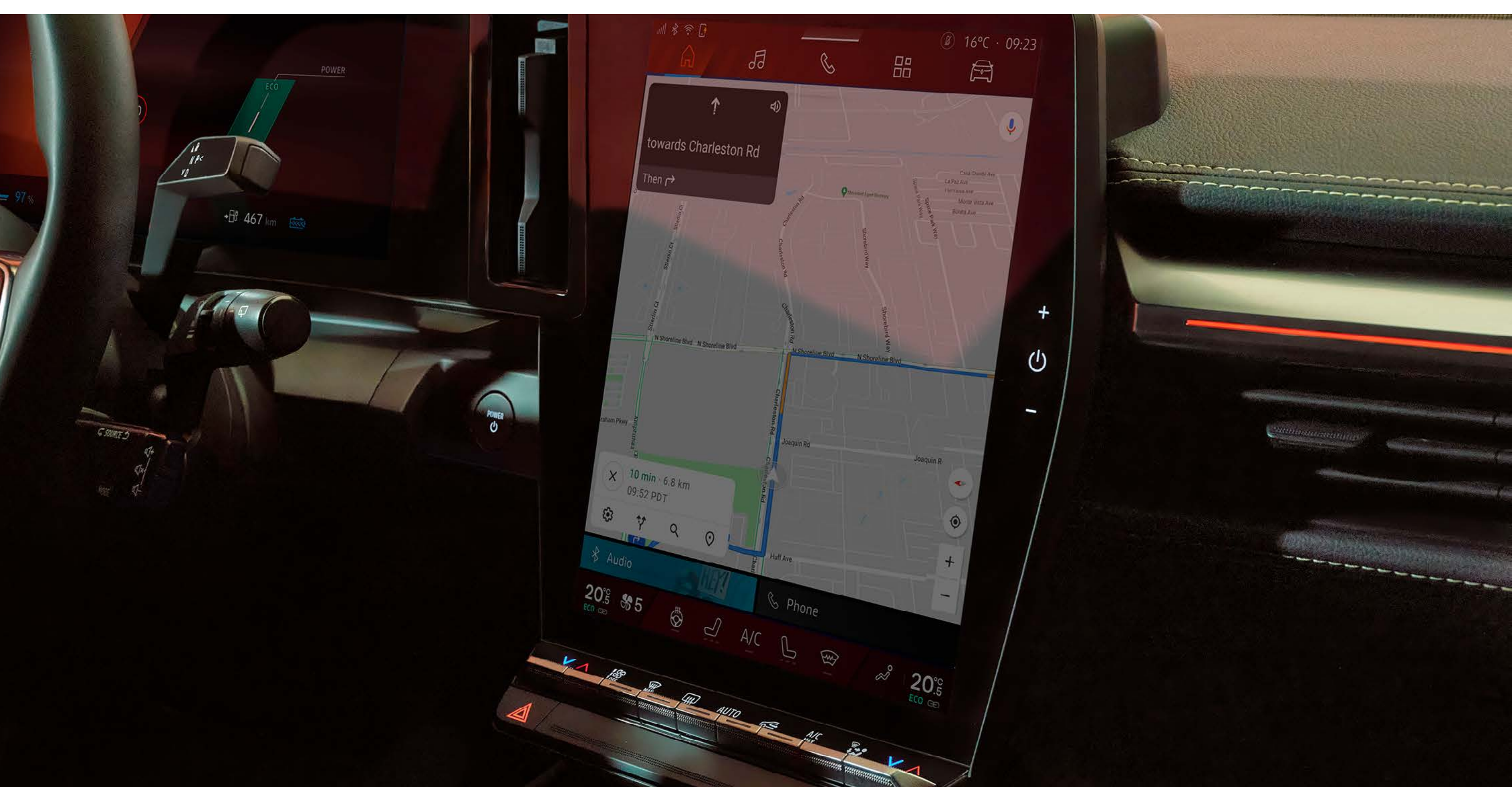

electric journey planner

On the road, the system suggests itineraries based on available charging points and your battery life. If there is an obstacle on the road, the route is automatically recalculated and other charging points are suggested based on the new itinerary.

charging point

Information on the availability and power of charging points in real time.

charge optimisation

Automatic pre-setting⁽⁴⁾ of the battery temperature for planned charging stops, resulting in faster charging.

personalised experience

Adapts to your usage habits and preferences.

With the voice assistant⁽²⁾, simply say: "Hey Google, lower the air conditioning!"



Google Play gives you access to up to 50 apps: music, podcasts, audio books, Spotify

Up to 50 applications⁽¹⁾ with exclusive content are available via Google Play⁽³⁾, including Waze, SongPop for Renault, and Amazon Music.

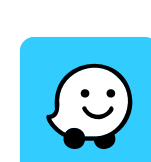

Waze is a community-based navigation app that shares information in real time. Waze boosts your peace of mind.

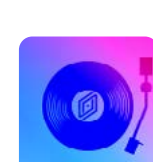

Drive to the beat with our new musical game – **SongPop for Renault**. Play together and rediscover popular songs with your family and friends!



Take to the road while listening to playlists, and much more, with **Amazon Music**, included with your Amazon Prime subscription.



If Spotify is more your bag, download the app to listen to your favourite music or podcasts.



Vivaldi browser is an efficient, fast web browser that respects your privacy.



Access all your favourite radio stations live, at any time, in France or abroad, with **Radioplayer**.



Ready to play? Quizzes, riddles and challenges await you! With Renault and **Les Incollables**[®], travelling is fun for all the family.



With **EasyPark**, plan and book millions of parking spaces across Europe. Enter your destination's address or navigate using the map.



Sybel is a unique platform to find your favourite podcasts, and discover exclusive original creations, audio books, new documentaries, etc.

(1) depending on version available on techno and iconic versions with programming of the charging point in Google Maps. Google, Google Maps, Google News, Waze and other marks are trademarks of Google LLC. (2) My Renault, Google Maps and Google Assistant connected services are provided free of charge for 5 years from the date of delivery of your vehicle. Google, Google Maps, Google News, Waze and other brand names are all trademarks of Google LLC. (3) the use of applications downloaded from Google Play requires a dedicated data package. To use these apps, share your phone's connection with your Renault. (4) available on the techno and iconic versions with programming of the charging point in Google Maps. Google, Google Maps, Google News, Waze and other marks are trademarks of Google LLC.

The My Renault application makes everyday life easier: preset the car's internal temperature, schedule charging, plan your journeys to automatically go via charging points, display the remaining driving range, and locate nearby charging stations.

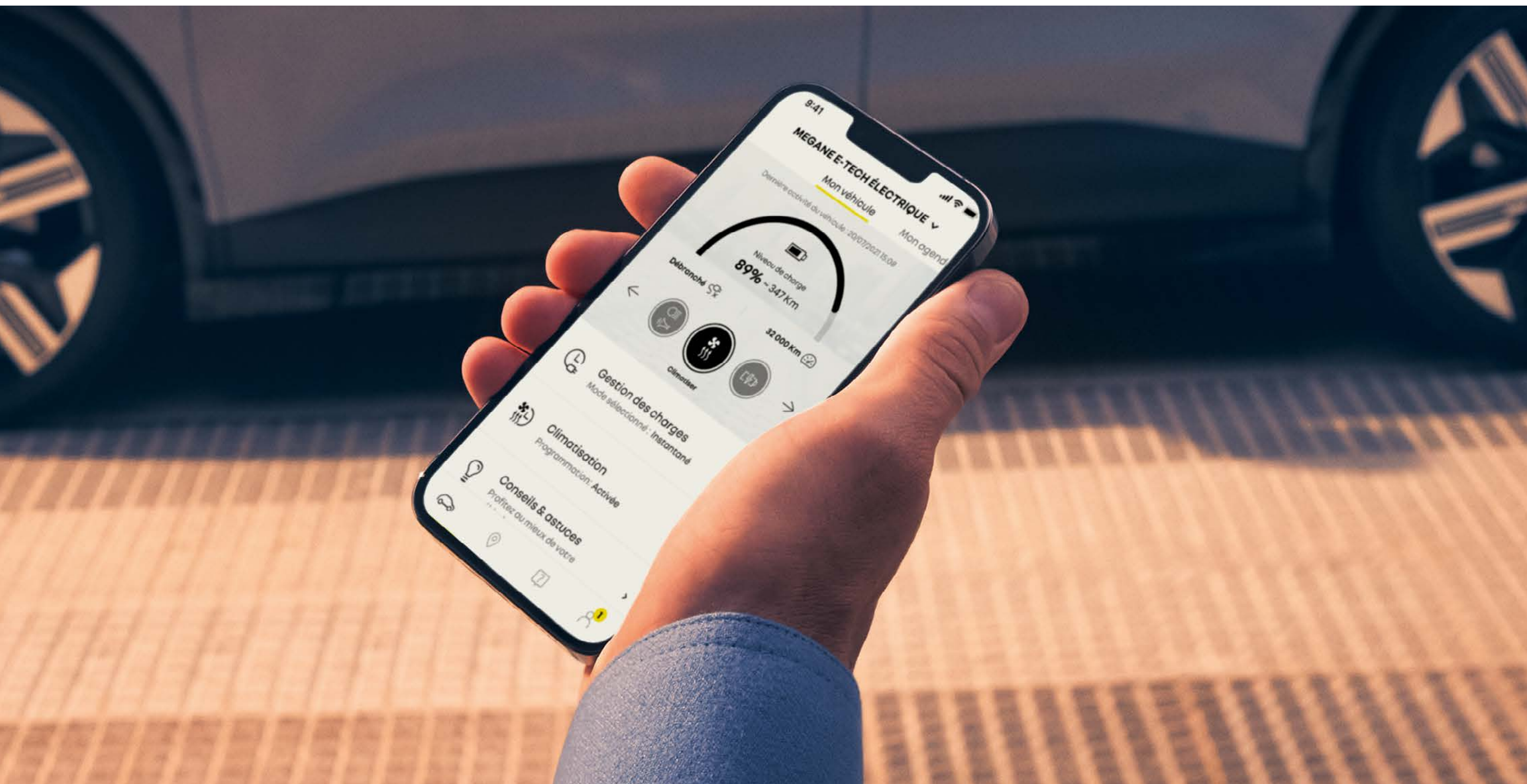

Harman Kardon high-fidelity sound

Featuring cocoon effect technology developed by Renault, the passenger compartment is perfectly soundproofed.

The new Harman Kardon* system provides an immersive experience for all passengers. It boasts total power of 410 W.

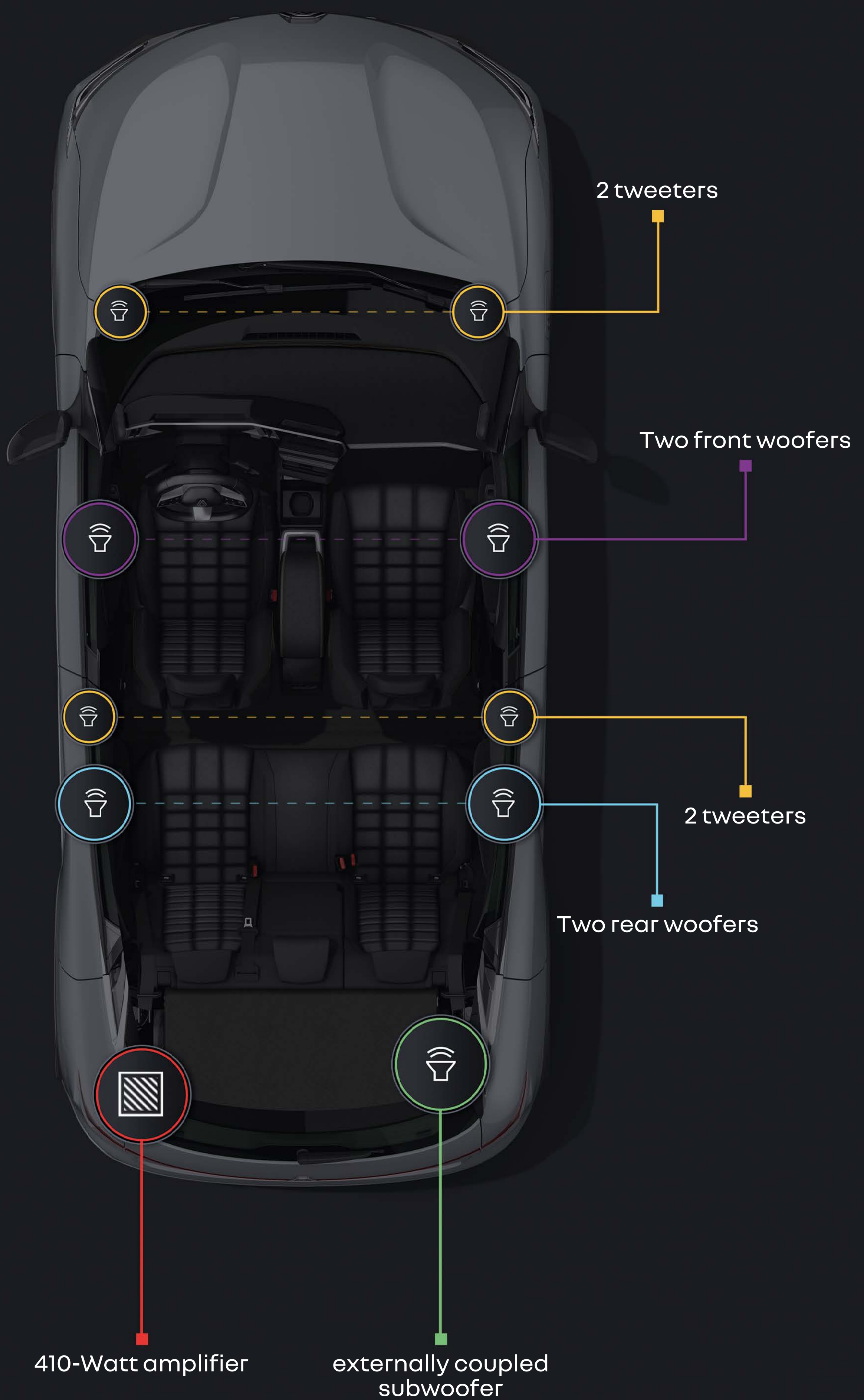

*standard for iconic version.

build yours →

04. interior space

440 litres of boot volume

Free of charging cables, which have their own storage area accessible via the false floor, the boot has a loading volume of 440 litres.



The platform specifically designed for electric vehicles features a completely flat floor (since there is no transmission tunnel). Available space is optimised: 33 litres of storage space in the cabin.

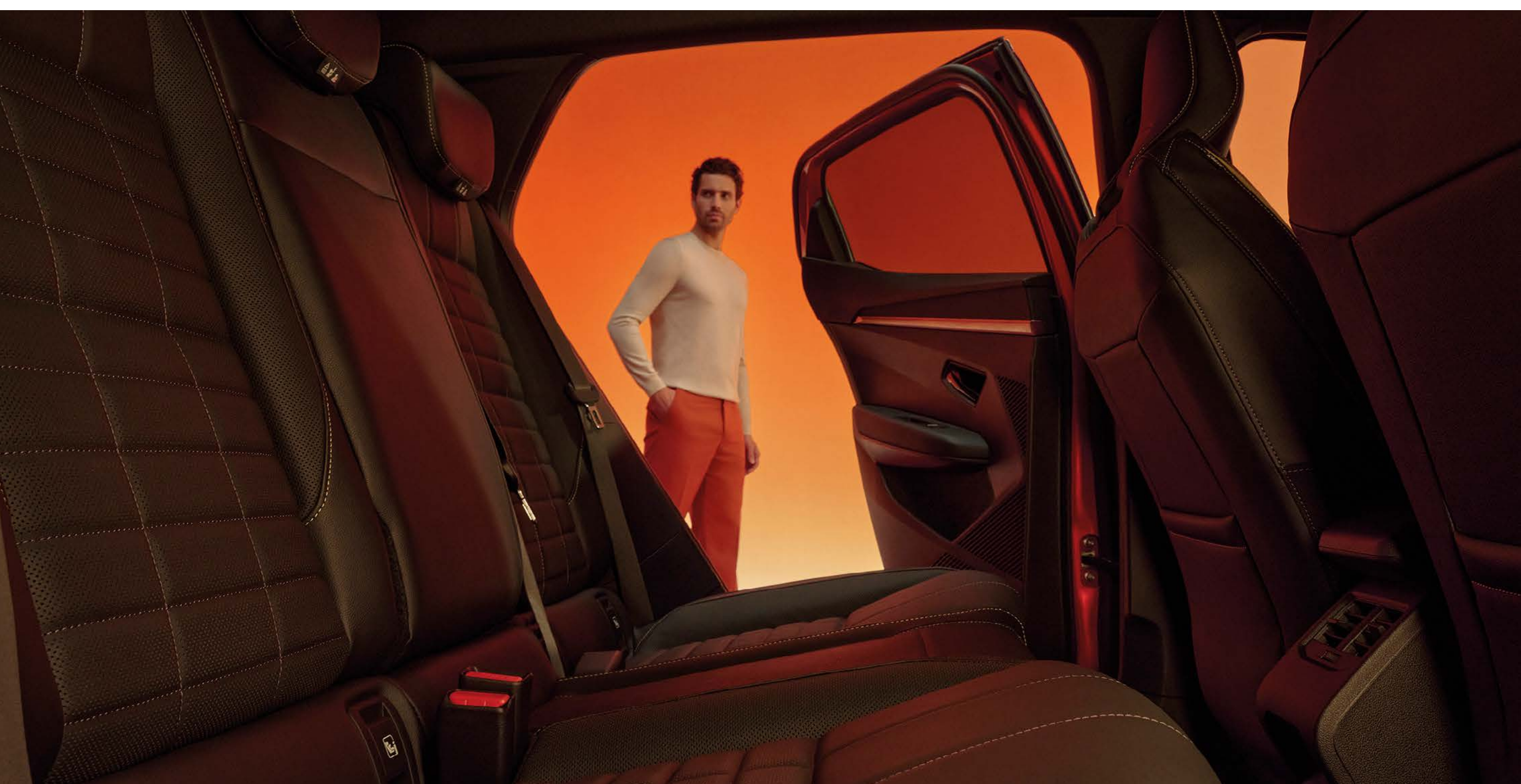

209 mm knee room in the rear

build yours →

05. advanced driver-assistance systems



up to 24 advanced driver-assistance systems*

As part of the human first program, Renault Megane E-Tech 100% electric comprises up to 24 innovative advanced driver-assistance systems.

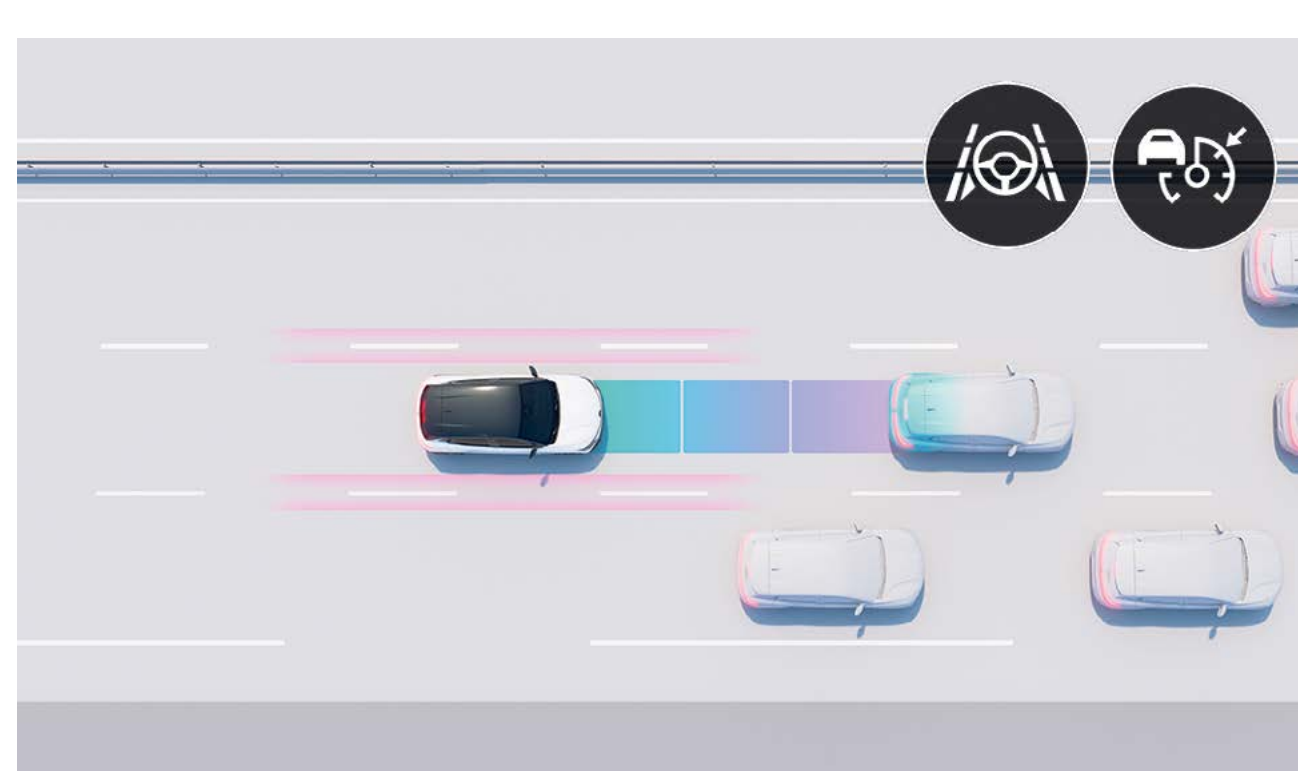

active driver assist
This system regulates your speed by taking the road environment into account, maintains safe distances and ensures you remain in lane. When traffic slows down, the vehicle stops and restarts automatically.



360° around view 3D camera
The 4 cameras, whose images recreate the vehicle's direct environment 360° around it, allow you to perform your manoeuvres effortlessly.

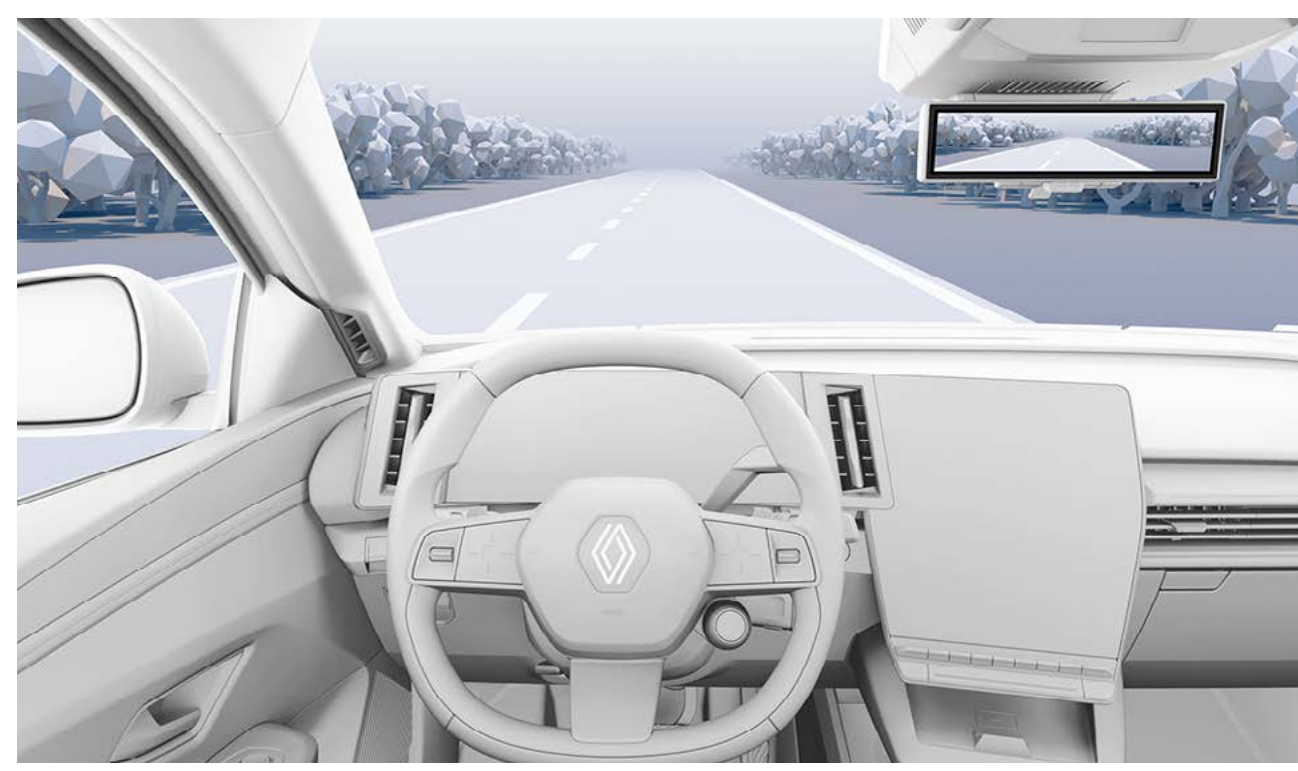

rear view camera
A camera positioned at the rear of the roof is combined with a rear-view camera system. The interior rear-view mirror provides an unobstructed view, even with tall passengers in the rear.

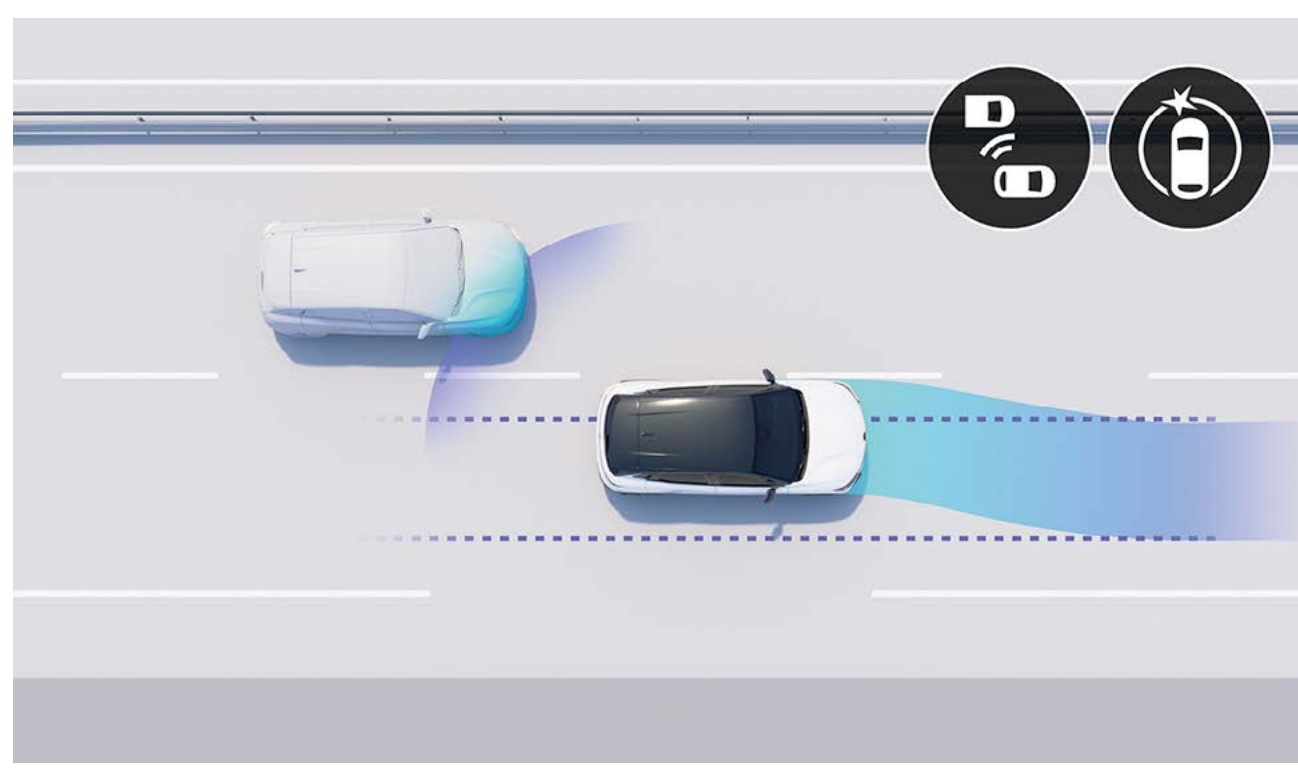

rear detection with emergency trajectory correction
The system warns you of a potential collision with an overtaking vehicle in the adjacent lane. If a collision is likely, it performs an automatic emergency trajectory correction.

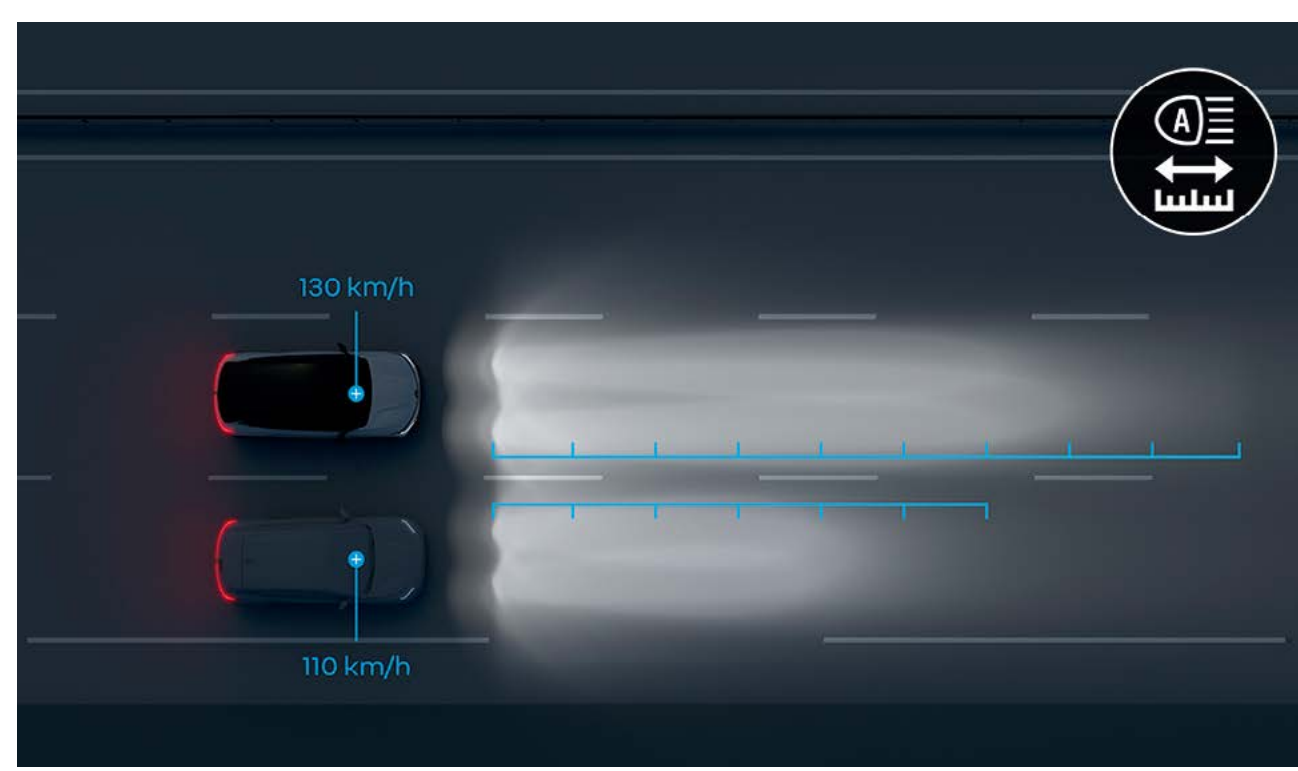

LED adaptive vision headlights
The system automatically adjusts the range and width of the front beam according to traffic conditions (speed, cornering) and weather conditions, for increased safety and driving comfort.

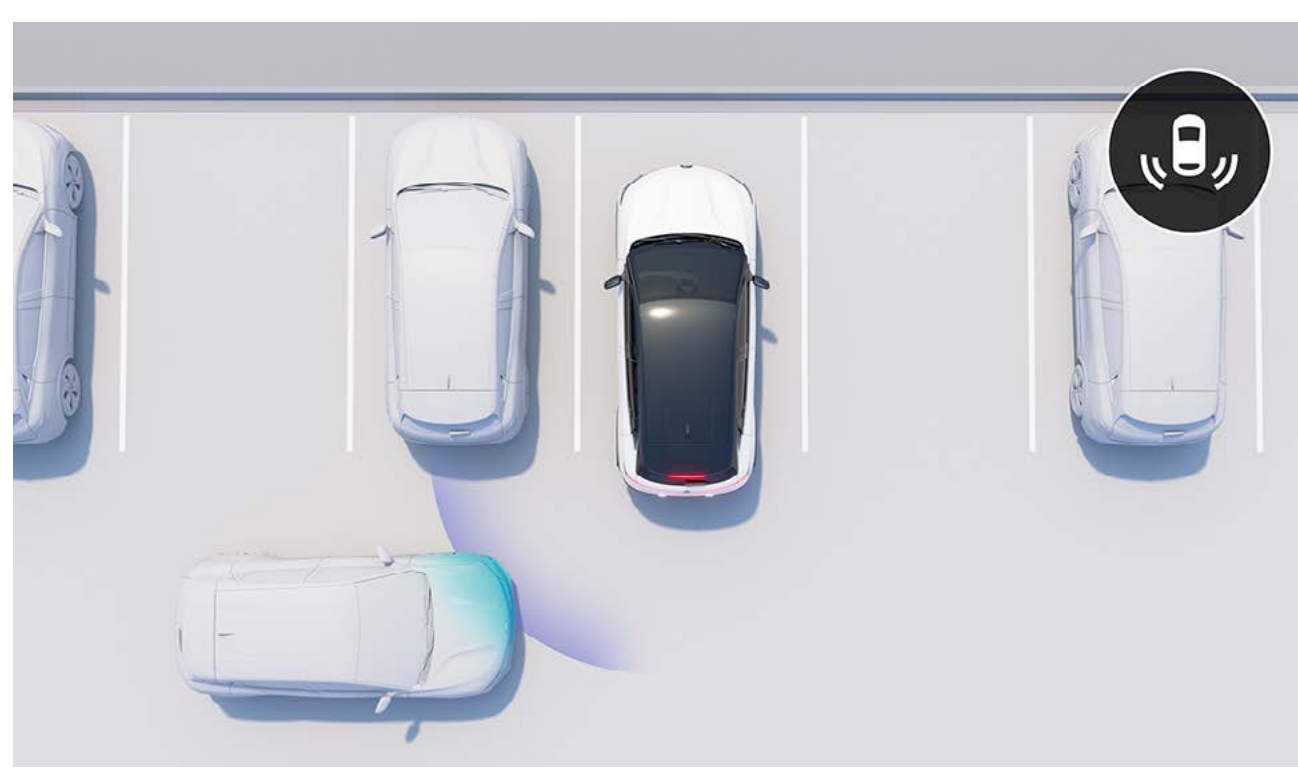

rear parking space exit warning
This warns you in the event of obstacles at the rear of the vehicle.

driver-assistance systems

- active driver assist
- hill start assist
- automatic high/low beam
- LED adaptive vision headlights (with integrated front fog light function)
- adaptive cruise control
- contextual adaptive cruise control

park assist systems

- rear parking assist
- front parking assist
- side parking assist
- 360° around view 3D camera
- rear view camera
- hands free parking
- auto-tilting & folding wing mirrors with puddle lamp

safety assistance systems

- distance warning alert
- blind spot warning and lane departure warning
- occupant safe exit alert
- emergency lane keep assist including solid line, oncoming traffic & road edge detection
- driver attention
- rear cross traffic alert with rear automatic braking system
- active emergency braking assist - urban and pedestrian / cyclist
- road sign recognition
- intelligent speed assistance [combines road sign recognition with overspeed prevention]

* advance driver-assistance systems is dependent on version. Please check full equipment list for more details.

build yours →

06. customisation

colours



glacier white (o)



ceramic grey (p)



shadow grey (mp)



midnight blue (mp)



flame red (mp)*



diamond black (mp)

o: opaque.

p: pearlescent.

mp: metallic paint.

photos not contractually binding.

*photo used for illustrative purposes. Flame red not available with titanium f1 blade.

06. customisation

exterior customisation



diamond black roof

possible combinations of vehicle and roof colours

colour / roof colour	diamond black
ceramic grey	yes ⁽¹⁾⁽²⁾
glacier white	yes ⁽¹⁾⁽²⁾
shadow grey	yes ⁽¹⁾⁽²⁾
diamond black	-
flame red	yes ⁽¹⁾
midnight blue	yes ⁽¹⁾⁽²⁾

(1) on techno version. (2) on iconic version..

build yours →

06. customisation

interior trims



evolution

- 9" multimedia openR link screen
- 12.3" driver information display cluster
- arkamys audio system
- heated seats & heated steering wheel



techno

- 12" multimedia openR link screen with navigation and Google in-built (assistant, maps, playstore)
- wireless phone charger
- arkamys audio system
- four-mode multi-sense (perso/sport/comfort/eco)
- paddle shifters for regenerative braking
- front and rear parking sensors



iconic

- around view 3D camera
- smart rear view mirror
- harman kardon audio system
- hands free parking



**download the versions
and equipment pdf (6 MB)**

06. customisation

upholstery

evolution



recycled fabric upholstery in mottled grey and black

techno and iconic



grey fabric made from recycled material upholstery

wheels

evolution



18" oston alloy wheel rims

techno



20" soren alloy wheel rims

iconic



20" enos alloy wheel rims

build yours →

06. customisation

accessory packs



storage pack
boot storage box

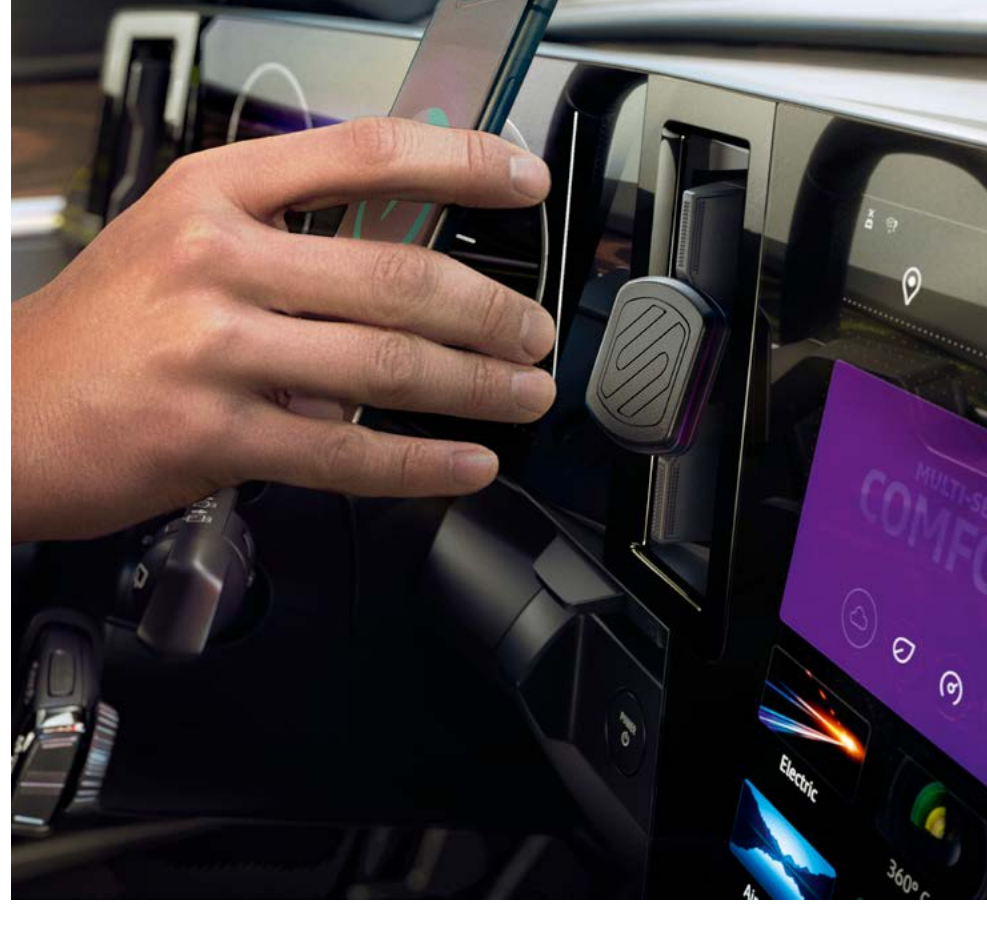

magnetic smartphone holder



rear tray table

storage pack+ available with 2 x rear tray tables and fixings



protection pack
satin grey door
mirror shells



boot mat



illuminated door sills



ev pack
3 pin domestic charging cable



double boot floor



family pack
child seat protector + kick mat



seat organiser



dash cam pack
front and rear dashcam



cycle pack
quickfix roof bars



roof mounted bike carrier for 2 bikes



touring pack
quickfix roof bars

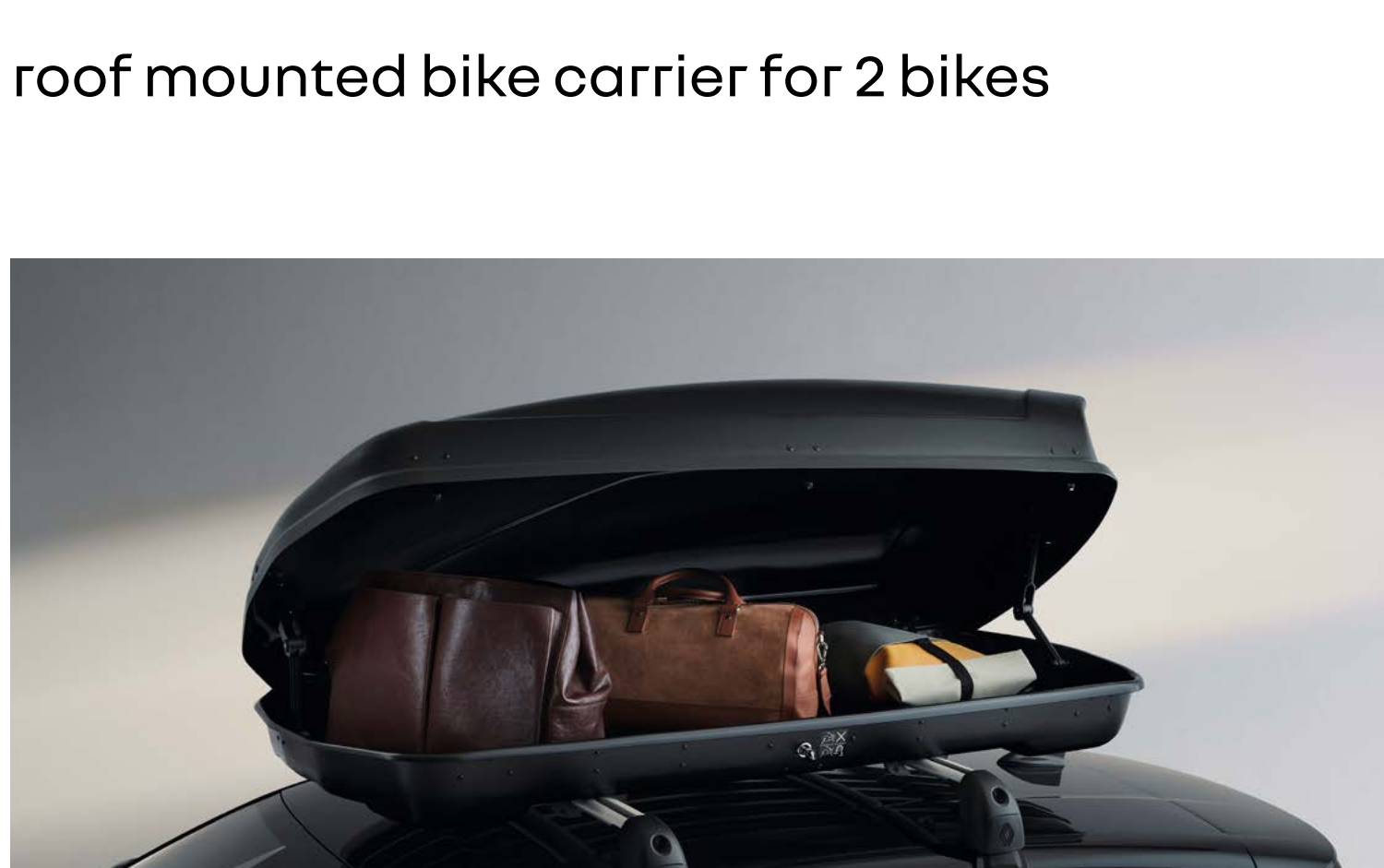

roof box 480L



towbar packs
swan neck towbar 13 pin
removable towbar 13 pin

premium delivery packs



premium textile floor
mats



safety kit



fabric boot liner

premium delivery pack

premium textile floor mats
safety kit

premium delivery pack+

premium textile floor mats
safety kit
fabric boot liner



spare wheel kit



All accessories purchased prior to vehicle registration come with a 3 year manufacturers warranty.

 **download the accessories
brochure PDF (6 MB)**

build yours →

menu ↑

06. customisation

batteries and engines

**220 hp
comfort
range**

battery type (kWh)

60

number of seats

5

range and consumption

certified driving range in WLTP cycle (miles)⁽¹⁾⁽²⁾

285

certified consumption in combined cycle (kWh/62miles)

15.2

wheel size of the certified version⁽³⁾

18"

useful battery capacity (kWh)

60

max. power output EEC kW (h.p.) at rated power (rpm)

220

max. torque EEC-Nm

300

(1) driving range in WLTP cycle, actual range depends on driving conditions (type of road, driving style and weather conditions). (2) in WLTP certification, the value corresponds to the vehicle version that has obtained the optimum value. (3) the size of the wheel rims may affect the vehicle's driving range.



**download the PDF (6 MB) of
the batteries and engines**

dimensions and volumes

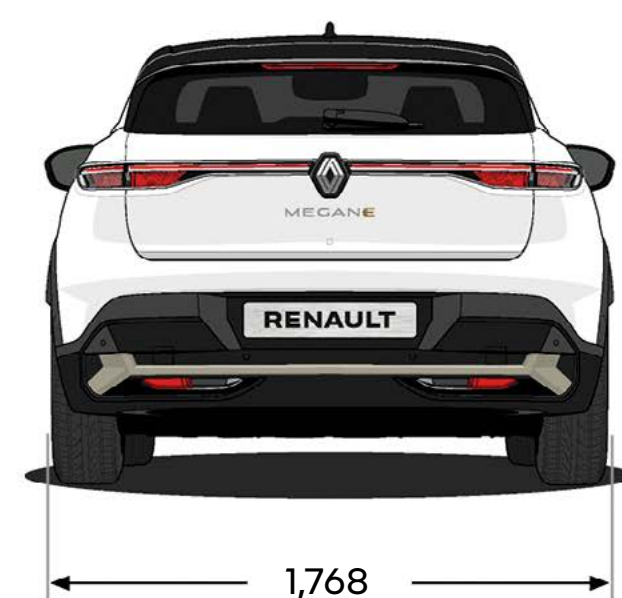
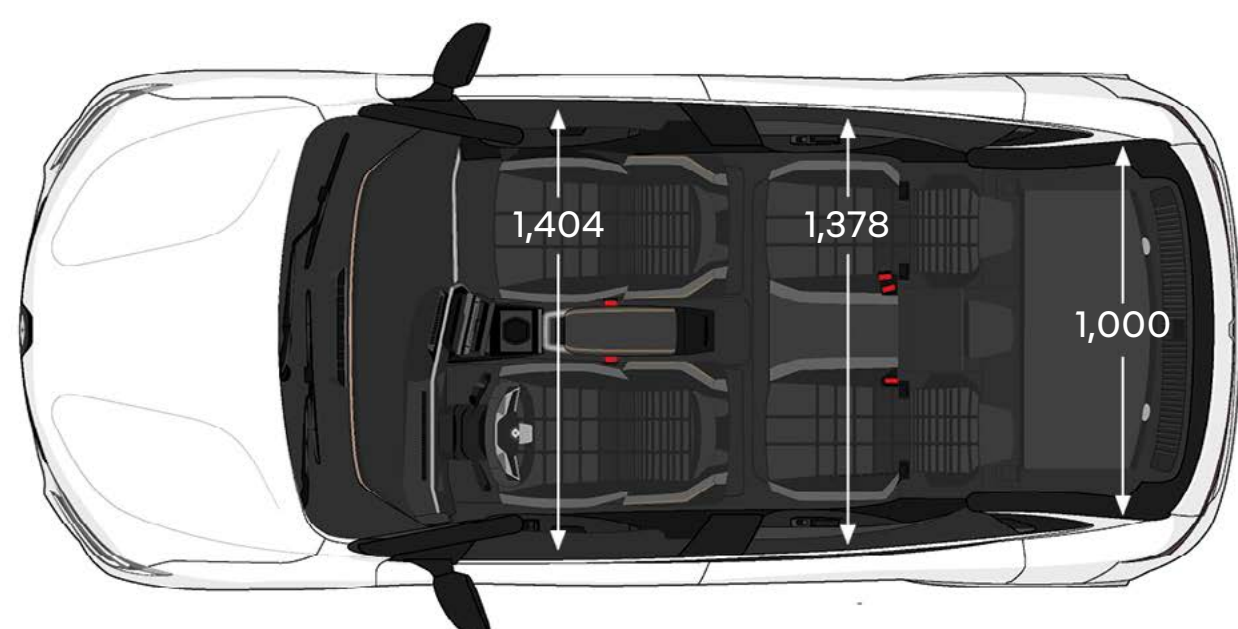
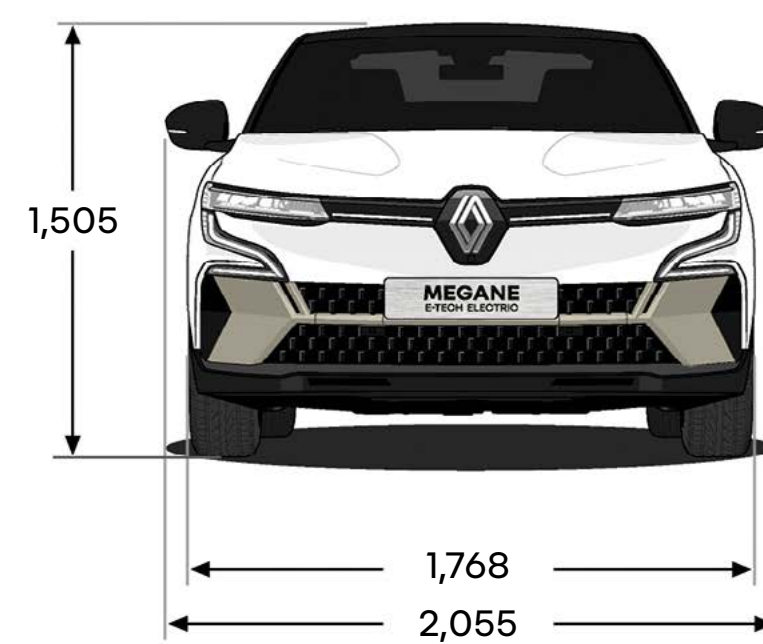
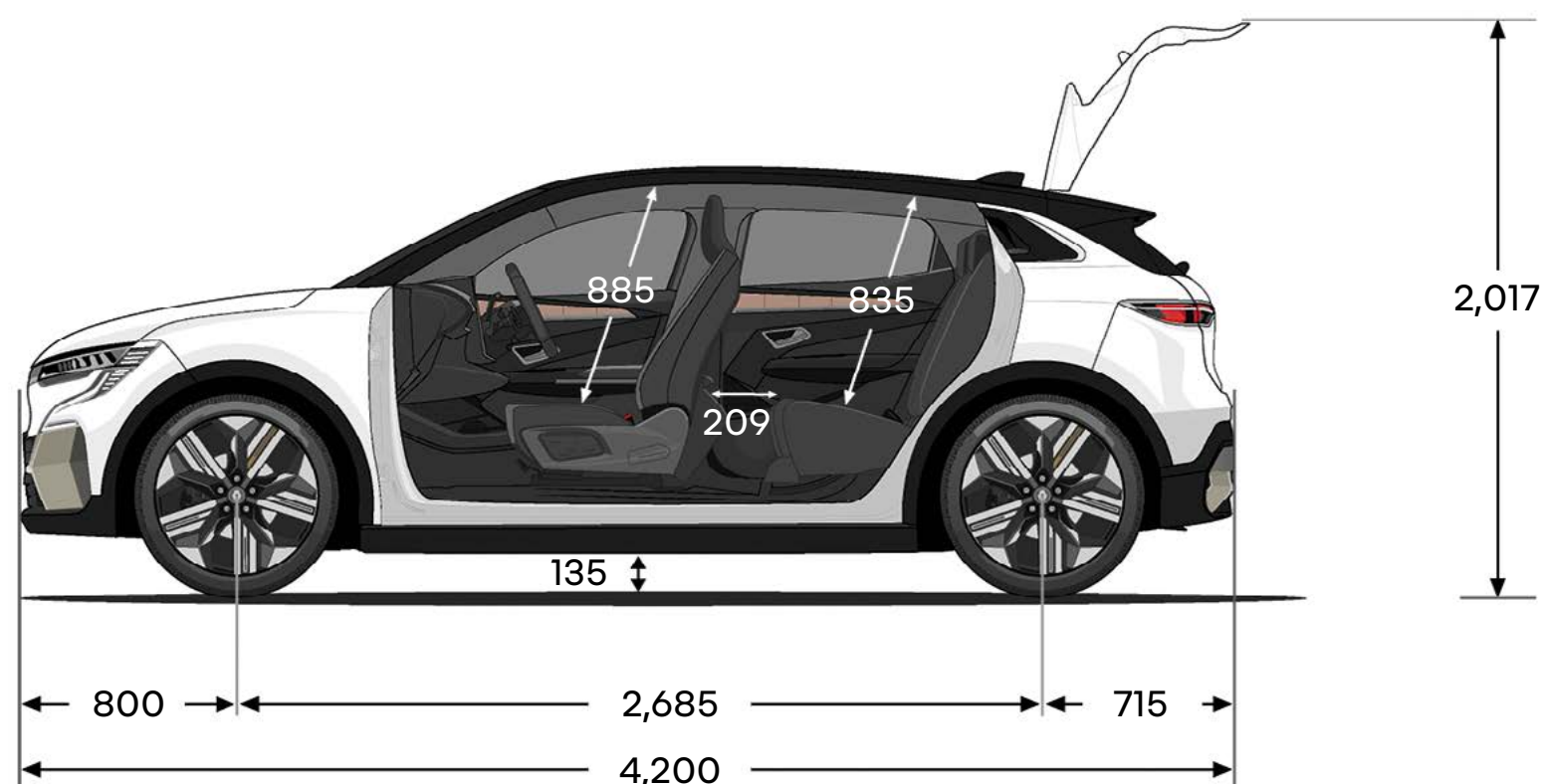

boot volume (litres)

min. boot volume	440
max. boot volume	1,332

dimensions in mm.

build yours →

the human first program is a comprehensive safety programme developed by Renault in cooperation with researchers, experts and firefighters.

because road safety concerns all road users, whether they are pedestrians, cyclists, motorists, the human first program by Renault is committed to:

1. prevent accidents by developing safety equipment and advanced driver-assistance and safety systems

numerous advanced driver-assistance systems/more than 60 safety features, up to 7 airbags, child seats (Isofix), Renault Fixe4sure solution / more than 2,000 safety-related patents filed since 1970

2 manage accidents once they have happened by drawing on innovations developed in collaboration with firefighters

QRescue / Fireman Access / more than 5,000 firefighters trained over 10 years in 19 countries worldwide / around 400 cars donated per year for their training

3. reduce the number of accidents and their severity by investing massively in R&D

safety score / safety coach / connected services / big data / artificial intelligence and cybersecurity systems

[find out more about the human first program](#)

glossary

E-Tech

100% electric, hybrid or plug-in hybrid technology developed by Renault.

regenerative braking

System for the recovery of energy during braking, which increases the vehicle's driving range: whenever the vehicle slows down, part of its kinetic energy is converted into electricity. The battery recharges when the driver lifts his or her foot off the accelerator pedal or presses slightly on the brake pedal.

reinforced domestic socket

A home charging solution that is more efficient than a simple domestic socket. Allows for more powerful (3.2 kW for a reinforced socket vs 2.3 kW for a standard socket) and more secure charging (fitted with a differential circuit breaker).

domestic charging point

Delivers a much higher intensity than a standard domestic socket, for more efficient and faster charging. It enables safer home charging thanks to its systems for controlling charging and protecting against overvoltage.

flexi-charger

Charging cable that can be used to plug a car into a domestic power outlet. Designed for occasional home charging, the flexi-charger should preferably be plugged into an electrical socket connected to a specific earth connection.

mode 2

For domestic use, this cable is needed to charge an electric vehicle using conventional sockets.

mode 3

This cable is needed to charge the electric vehicle on a wallbox or with public infrastructure.

useful capacity

Amount of energy contained in the battery that can be used by the vehicle. Value expressed in kilowatt hours (kWh).

kWh

Abbreviation of kilowatt hour. Unit of energy which corresponds to 1 kW of power consumed over one hour.

kW

Abbreviation of kilowatt. Unit used to measure the power of a vehicle's engine, whether it is electric or powered by an internal combustion engine. The kilowatt measures the direct current (DC) or alternating current (AC) charging power.

AC charge

Low to medium power alternating current charging (max. 22 kW). This is the charging method most commonly found in homes or at most public charging points.

DC charge

Rapid direct current charging (min. 50 kW). Requires a specific fast charging station, available only on the public network.

My Renault

Renault application connected to your vehicle that can be downloaded onto your phone from Google Play or the App Store. You can use it to locate nearby charging stations, find your vehicle, schedule charging and plan your journey in advance, as well as to display remaining range and preset the temperature of the passenger compartment.

heat pump

Equipment used to heat the passenger compartment of your electric car. The heat pump significantly reduces your consumption of electrical energy and maximises your driving range when the exterior temperature drops below 15°C.

kWh/100 km

Unit of measurement for the average consumption of energy of an electric or plug-in hybrid car over a distance of 100 km. This is the equivalent of "litres per 100 kilometres" for electrified vehicles.

WLTP

Worldwide harmonised Light vehicles Test Procedure. This protocol defines the exact conditions under which vehicle tests are carried out, irrespective of the manufacturer, making it possible to share and compare information that is important to consumers and legislators, such as fuel or electricity consumption, the range of electric or rechargeable hybrid vehicles, and pollutant emissions that are much closer to everyday use.

Mobilize, services to make your life easier in electric vehicles

Enjoy a completely practical and efficient electric experience: installation of a charging point in your home as soon as you purchase the vehicle, support services delivered via your mobile, card for accessing and paying for the use of European charging points.



Mobilize power solutions

Installation of home charging solutions.

Mobilize charge pass

Easier payment and location of charging points.

[discover Mobilize solutions](#)

Renault care service

We are always at your side to make the driving experience easier and save you time with the maintenance of your Renault: online quotes and appointments, fixed-price packages, maintenance contracts, insurance and assistance, personalised My Renault programme... Take advantage of our simple and fast solutions tailored to your needs.

[find out more about Renault care service](#)



Every precaution was taken to ensure that this brochure was accurate and up-to-date when published. This document has been created using pre-production and prototype models. In line with its policy of continuous product improvement, Renault reserves the right to modify the specifications, vehicles and accessories described and featured at any time. Any such modifications are communicated to Renault dealers as quickly as possible. Depending on the country of sale, versions may differ and some equipment may be unavailable (standard, optional or accessory). Please contact your nearest dealer for the latest information. For reasons to do with the medium, the colours featured in this document may differ slightly from those of the actual paintwork or interior trim. All rights reserved. Reproduction in any format and by any means of all or part of this brochure is prohibited without prior written authorisation from Renault.

Publicis - photo credits: P. McLean, © Renault Marketing 3D-Commerce - July 2024.
Renault s.a.s, a French simplified joint stock company with a share capital of €533,941,113.00 / 122-122 bis avenue du Général Leclerc - 92100 Boulogne-Billancourt Cedex, France - registered on the Trade and Companies Registry (R.C.S.) of Nanterre under number B 780 129 987 / tel.: 0806 00 20 20.



build yours →