

SUBARU XV



**SUBARU**

*Confidence in Motion*



# THE COMPACT CROSSOVER.

AS ONLY SUBARU CAN.

Introducing the all-new SUBARU XV. A compact, all-wheel drive SUV that's as sure-footed and reliable around town as it is in the countryside. A horizontally-opposed SUBARU Boxer engine, Lineartronic transmission and Symmetrical All-Wheel Drive provide superior road-holding, handling and grip - qualities that make every SUBARU so controlled and reassuringly safe to drive. Two Boxer petrol engines are available, plus SE and SE Premium trim levels.

All-new XV. The capable, refined compact crossover by SUBARU.



## PARK UP. AND ADMIRE.

The XV features SUBARU's latest equipment as standard. EyeSight<sup>™</sup> driver assist technology provides warnings and collision avoidance assistance, whilst X-MODE with Hill Descent Control confidently manages braking and power on steep inclines and descents whilst you steer. XV's keyless entry with push button start system makes short work of setting off.

XV also benefits from next-generation design and manufacturing enhancements. SUBARU's Global Platform (SGP) creates a chassis that offers higher rigidity, increased strength, lighter weight, better rolling resistance and responsive steering - further increasing all-round safety.



\* EyeSight is a driving support system which may not operate optimally under all driving conditions or for all objects. The driver is always responsible for safe and attentive driving and observance of traffic regulations. See Owner's Manual for complete details on system operation and limitations.



## FOLLOW YOUR OWN PATH.

Bold. Sporty. Confident. The SUBARU XV's exterior fuses athletic lines with rugged, capable styling. Angular wheel arch extensions coupled with two eye-catching wheel designs hint at XV's all-wheel drive prowess and impressive 220mm ground clearance.

From a distinctive hexagonal front grille, the design flows through to the sporty LED Steering Responsive Headlights - which, when traffic is detected, can automatically switch from high to low beam headlights using High Beam Assist.

A lowered rear roofline with black rear spoiler and surrounds accentuates XV's width and stature. The flowing roof profile, complete with shark fin antenna, increases aerodynamic performance whilst retaining interior space. Whatever your destination, arrive in style in the XV.



## CITY STYLE, COUNTRY CAPABLE.

The SUBARU XV is always up for a challenge - so it's engineered to give you confidence at the wheel. Its high driving position ensures excellent visibility, whilst Symmetrical All-Wheel Drive and a high ground clearance fearlessly conquer rough roads. With X-MODE, negotiating steep inclines and descents is effortless. Choose your destination for the weekend: XV will get you there safely and comfortably.



### X-MODE ENGAGED

X-MODE gives you reliable control at the push of a button, taking command of the engine, transmission, Symmetrical AWD, brakes, and other components to help you navigate through challenging conditions and varying terrain. When X-MODE is activated, Hill Descent Control automatically maintains a constant speed when travelling downhill: all you have to do is steer.

# LOAD UP. SET OFF.

EXPLORE AND ENJOY.

For outdoor sports and hobbies, or weekends away, a vehicle must be spacious and versatile. The SUBARU XV offers ample storage capacity so you can bring all your kit and baggage along. Wherever your plans take you, your XV is ready.



## SMART STORAGE SOLUTIONS

The XV offers ample, flexible storage. The wide, large boot opening makes loading and unloading easy, whilst 60/40 split rear folding seats quickly create even more flexible space. For larger items, there are easy-to-use roof rails\*.

\* Requires purchase of optional accessory attachments to carry items on the longitudinal roof rails.



Open the doors of the SUBARU XV and you can't fail to notice the refined, sporty styling: it's even more spacious and well-equipped than before. The contoured seats provide you and your passengers with luxurious support to keep everyone comfortable, even on the longest rides.

## DETAILS MAKE THE DIFFERENCE.



01

### 01. POWER-SLIDING, TILT-ADJUSTABLE SUNROOF\*

Premium models come with a sunroof. Let daylight or sunshine flood into the cabin in seconds.



02

### 02. ORANGE SEAT STITCHING

The ultra-comfortable contoured seats, upholstered in cloth or leather\* feature distinctive orange stitching - yet another detail that adds to XV's finesse.



03

### 03. REAR SEAT CENTRE ARMREST

The interior of the XV offers comfort for all passengers - including cup holders in the rear seat centre armrest.

\* Available on Premium models only.





# STAY IN TOUCH. FEEL CONNECTED.

The SUBARU XV is equipped with a completely redesigned next-generation infotainment system that keeps you connected wherever you go. The 8" multi-function colour touchscreen head unit display provides intuitive access to navigation<sup>\*1</sup> connected devices and audio sources, whilst a redesigned multi-information display provides key vehicle stats. These displays all improve convenience, safety, and enjoyment. In touch and in control - that's how you'll always feel inside XV.



01



02



03

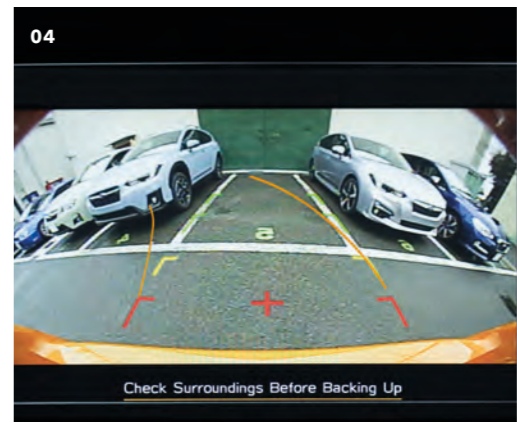

04

### 01. APPLE CARPLAY™ AND ANDROID AUTO™\*2

Apple CarPlay™ and Android Auto™ mirror compatible apps from your smartphone onto XV's touchscreen, allowing you to make phone calls and dictate text messages hands-free, reducing distractions when you're on the road<sup>\*3</sup>.

### 02. MULTI-INFORMATION DISPLAY

The 4.3" LCD multi-information display at the top of the instrument panel provides you and your passengers with useful information in an easy-to-understand view. It offers a fuel economy screen; eco-evaluation screen; driving condition; and clock with outside temperature and maintenance information.

### 03. INSTRUMENT PANEL

The full-colour LCD meter display helps you understand useful driving information at a glance so you can keep your eyes on the road.

### 04. REVERSING CAMERA

When you engage reverse gear, the reversing camera displays a live colour image along with guidelines to assist in parking manoeuvres.

\*1 Available on Premium models only.  
\*2 Driver is responsible for safe driving. Please refrain from operating the touchscreen while driving.  
\*3 This functionality uses your smartphone's data.



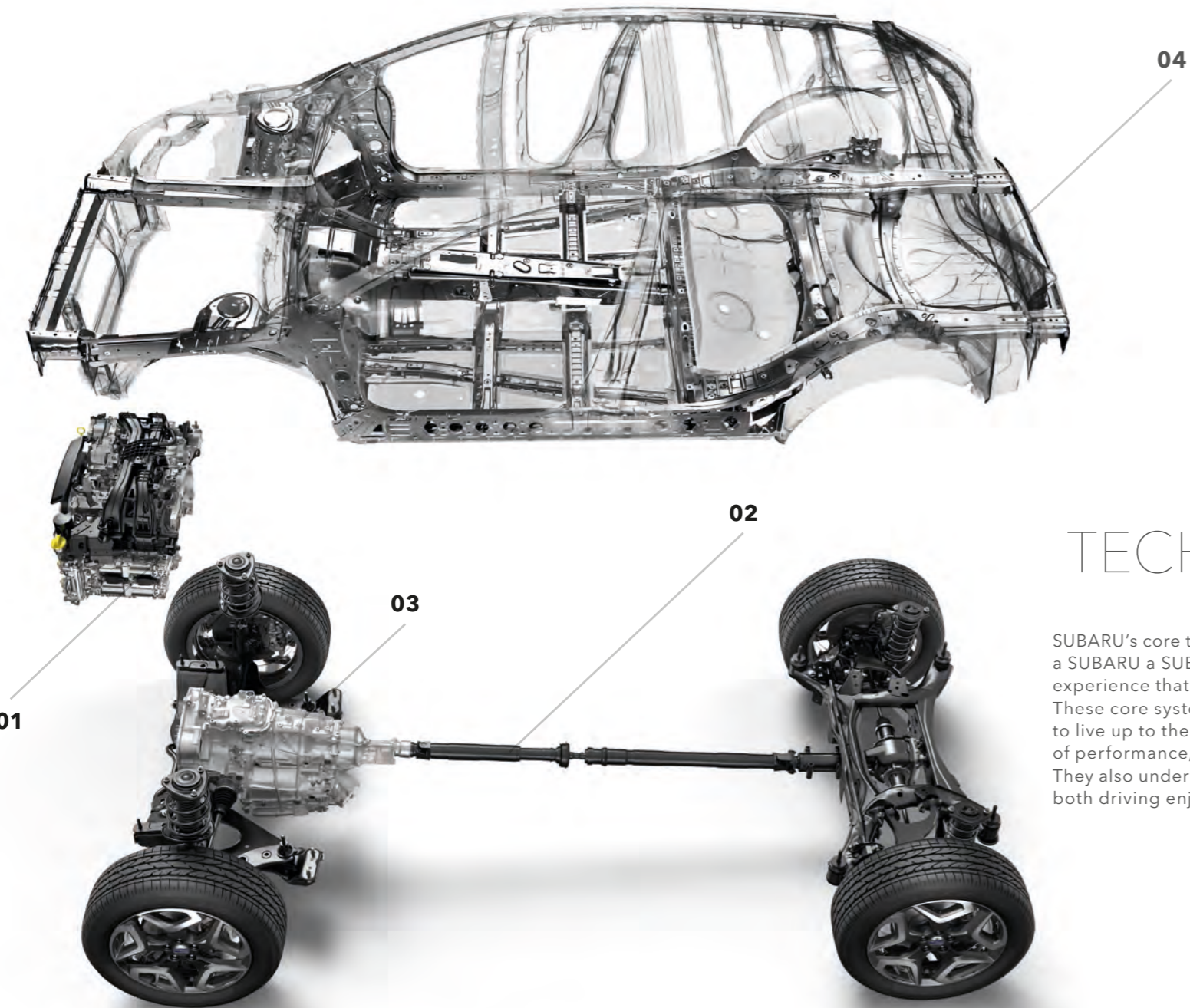

## SUBARU CORE TECHNOLOGY.

SUBARU's core technologies define what makes a SUBARU a SUBARU - and the unique driving experience that only our vehicles can provide. These core systems enable SUBARU vehicles to live up to the brand's exceptional standards of performance, comfort, safety, and reliability. They also underpin SUBARU's promise to deliver both driving enjoyment and peace of mind.

### 01 BOXER ENGINE

The horizontally-opposed configuration of the SUBARU Boxer engine places pistons 180 degrees apart for a lower, flatter profile than other engine types. One of the main benefits of this configuration is that the pistons' movements naturally counteract each other, helping to reduce vibration and noise and delivering a smoother driving experience. The engine's shape and unique piston movement allow it to be installed lower down and further back than a conventional engine, giving the whole car a low centre of gravity and balanced weight distribution for exceptional handling and poise.

### 03 LINEARTRONIC + ACTIVE TORQUE SPLIT AWD

SUBARU Lineartronic is a Continuously Variable Transmission that moves between a span of gear ratios to provide smooth acceleration while keeping the engine at its optimal rev range. Lineartronic works particularly well with Symmetrical AWD as it preserves momentum that is often lost during gear changes on a manual or traditional automatic transmission. When the clutch pedal is depressed on a manual or the lock up clutch is released on a normal automatic, you break power to the wheels causing them to slow and lose performance.

#### A PERFECTLY-BALANCED CONFIGURATION

The design, shape and position of the Boxer engine results in the car having a very balanced weight distribution. This contributes to the car's excellent handling and offers increased stability compared to V or transverse engine types.

The Boxer engine, with its unique configuration, sits low in the chassis and is located further back allowing engine weight to be more evenly distributed over all four wheels.

### 02 SYMMETRICAL ALL-WHEEL DRIVE

SUBARU's permanent Symmetrical AWD maximises handling and enhances control on all roads in almost any conditions. Unlike any other all-wheel drive configuration, the engine, transmission and propshaft are positioned in a symmetrical straight-line layout which provides a direct route for traction and delivers a maximum transfer of power to all four wheels at all times. The driveshafts are similar lengths, reducing torque steer and eliminating the need for additional controls or weights to be added as the symmetrical design is inherently stable, producing natural balance and performance for a safer ride.

In contrast, Lineartronic helps to maintain traction by continuously providing power to the wheels at all times. Lineartronic is paired with Active Torque Split AWD which controls torque distribution between the front and back wheels. Normal torque split is set to 60% at the front and 40% to the rear. However, sensors constantly monitor changes in grip, vehicle speed and stability of the car and will in real time adjust the torque to each wheel, maintaining optimum grip, if more demanding conditions are identified.

In contrast, V and transverse engine positioning is restricted by the bulkhead. They have to sit further forward, compromising the vehicle's balance and stability.

In addition, V-type engine weight is positioned above the wheel line making it top heavy. Transverse engine weight is positioned above the wheel line and is also heavier on one side. Boxer engine weight is positioned centrally in line with the wheels, making a rigid structure that is resistant to side to side motion and body roll when cornering.

### 04 SUBARU GLOBAL PLATFORM

The SUBARU Global Platform will underpin the next generation of SUBARU vehicles. Enhancing all-around safety and performance, it offers a driving experience you can only find in a SUBARU. It's the future of SUBARU - and delivers even more enjoyment and peace of mind to all drivers and passengers.

#### 1. IMPROVED SAFETY PERFORMANCE

Body strength is increased by 40%. In the event of a collision, the frame can absorb and safely dissipate more energy. The new frame design also improves energy dispersal, directing more energy safely beneath the seating compartment.

#### 2. BETTER STABILITY AND HANDLING

By increasing rigidity of the body, front suspension and rear subframe, XV has enhanced straight-line stability and minimal body roll. More responsive handling allows the driver to better steer the car as intended and improves hazard avoidance.

#### 3. ENHANCED RIDE QUALITY

Vibrations and noise have been minimised to improve passenger comfort. Suspension improvements and a highly rigid chassis provide a quiet, comfortable journey for all.

#### BALANCED WEIGHT DISTRIBUTION OF SUBARU BOXER ENGINE

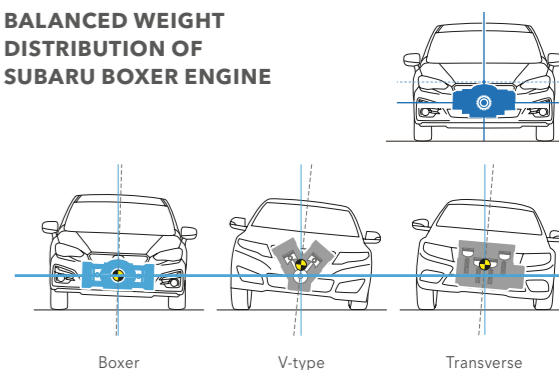

Boxer

V-type

Transverse

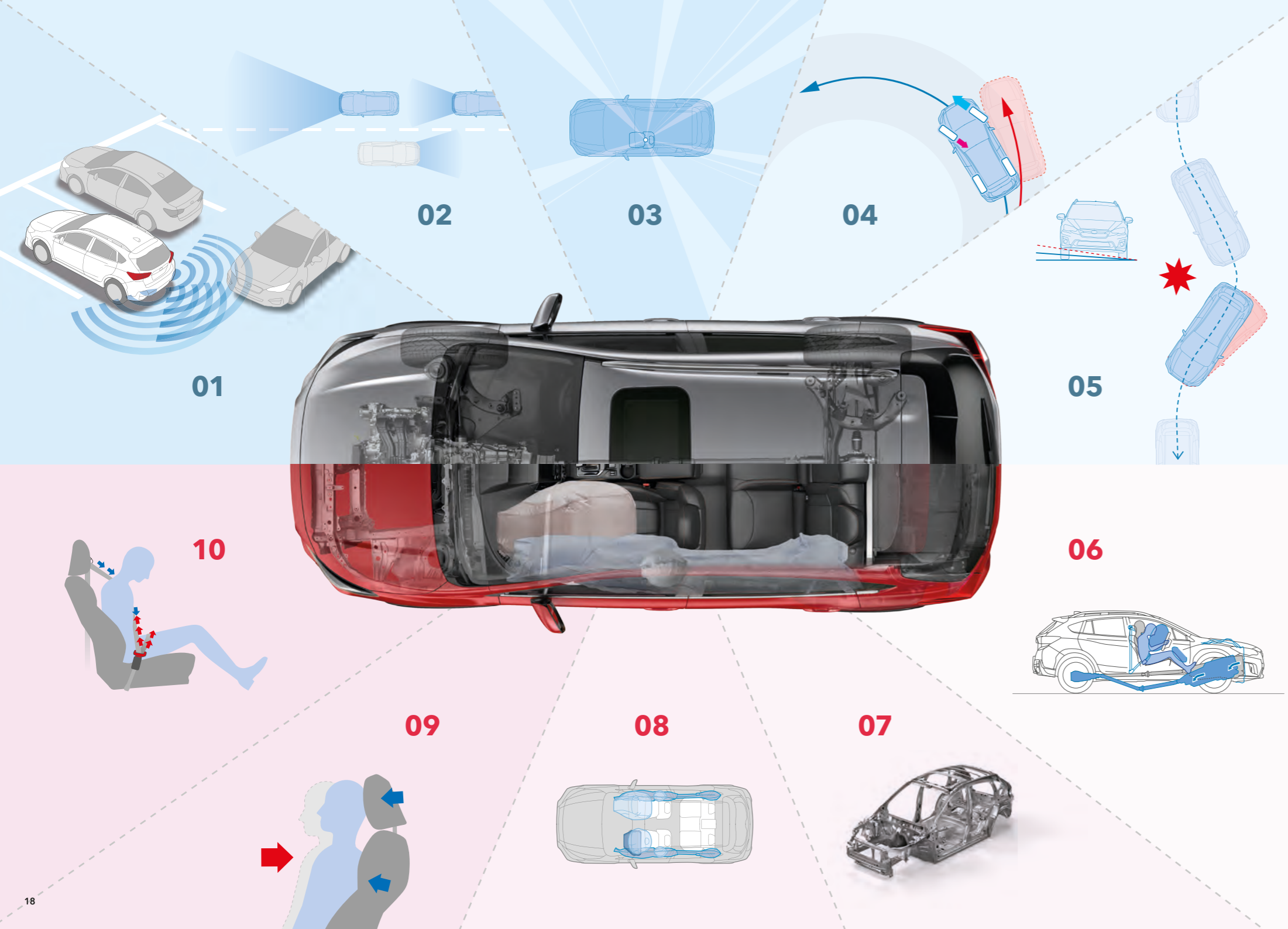

**01 SUBARU REAR VEHICLE DETECTION\*1**  
 SUBARU Rear Vehicle Detection (SRVD) includes Blind Spot Monitoring, Lane Change Assist & Rear Cross Traffic Alert. Sensors placed at the rear of the vehicle alert you to vehicles in your blind spots for safer lane changes and can also warn you of potential collision danger when reversing out of a parking space.

**02 HIGH BEAM ASSIST\*1**  
 High Beam Assist (HBA) increases visibility and safety when driving at night by automatically toggling the high beams on and off when oncoming traffic is detected.

**03 VISIBILITY**  
 Design improvements have been made with the viewing angle of the driver in mind to offer better front and rear visibility.

**04 VEHICLE DYNAMICS CONTROL SYSTEM**  
 The Vehicle Dynamics Control System monitors and analyses if the vehicle is following the driver's intended course via an array of sensors. If the vehicle begins to veer from its intended path, the All-Wheel Drive torque distribution, engine output, and brakes at each wheel are adjusted to assist in keeping the vehicle on course.

## SUBARU GLOBAL PLATFORM (SGP)

The SGP's enhancements throughout the chassis - higher rigidity, increased strength, better rolling resistance and responsive steering - particularly benefit these safety systems.

**05 HAZARD AVOIDANCE**  
 The lower centre of gravity design, enhanced suspension system, and rigidity improvements provide a vehicle that responds immediately when evasive actions are taken, helping you to avoid hazards on the road.

**06 CABIN-PROTECTING LAYOUT**  
 In the event of a collision, the low-mounted engine and gearbox are designed to both absorb the impact and drop safely below the passenger compartment, protecting occupants' legs. To allow for this movement, the cradle securing the engine is engineered to collapse, allowing the engine to slide downwards.

**07 RING-SHAPED REINFORCEMENT FRAME**  
 The Ring-shaped Reinforcement Frame makes better use of high tensile steel panels and has been structurally redesigned for more efficient energy absorption from impacts in all directions.

**08 SRS AIRBAGS\*2**  
 Front SRS\*2 airbags, front side SRS\*2 airbags, curtain SRS\*2 airbags, and a knee SRS\*2 airbag are standard on XV to give all passengers a higher level of protection in the event of a collision.

**09 WHIPLASH-REDUCING FRONT SEATS**  
 Designed to enhance comfort and help the driver feel more planted for greater control, these seats can also help reduce the possibility of whiplash resulting from certain types of collisions.

**10 LOCKING-TONGUE SEATBELTS**  
 During an impact, the locking tongue limits movement in the seatbelt and reduces impact in the lower chest area to improve safety and reduce injury levels.

\*1 The driver is always responsible for safe and attentive driving and observance of traffic regulations. Please do not depend solely on SUBARU Rear Vehicle Detection or High Beam Assist for safe driving. There are limitations to the recognition features of these systems. See Owner's Manual for complete details on system operation and limitations.  
 \*2 SRS: Supplemental Restraint System. Must be used with seatbelts.

ACTIVE SAFETY

PASSIVE SAFETY

**SUBARU'S WORLD-LEADING DRIVER ASSIST TECHNOLOGY.**

At SUBARU, we believe in all-around safety. An important part of that is pre-collision safety: making every effort to ensure an accident never happens. That's why we created EyeSight\*, SUBARU's cutting-edge driving support system. Like a second pair of eyes for the road ahead, EyeSight uses two stereo cameras capturing three-dimensional colour images with excellent image recognition, nearly as capable as the human eye. More accurate than traditional camera and sensor

technologies, EyeSight uses images from both cameras to precisely determine shape, speed and distance, meaning it not only detects vehicles but also motorbikes, bicycles and pedestrians\*. When a potential hazard is identified, it warns the driver and even applies the brakes if necessary, to help avoid an accident. With excellent safety performance, EyeSight gives the driver ultimate peace of mind.



**DRIVER ASSIST**

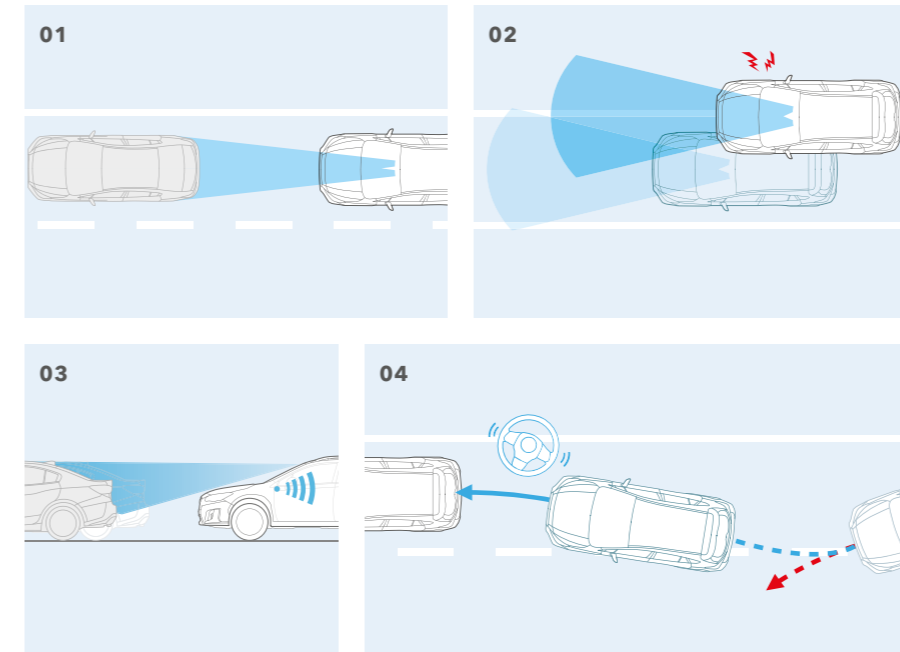

**01. ADAPTIVE CRUISE CONTROL**

Adaptive Cruise Control allows the driver to set vehicle speed and distance to the car in front. It constantly monitors distance and speed then adjusts the engine, transmission and brakes accordingly to maintain speed in line with the traffic flow. Designed for use on motorways and similar roads, Adaptive Cruise Control improves driver comfort and convenience on long drives.

**02. LANE SWAY AND DEPARTURE WARNING**

Lane Sway and Departure Warning will alert the driver with a visual and audible warning if the vehicle sways or departs its lane without indicating.

**03. LEAD VEHICLE START ALERT**

It's easy to become distracted when waiting in stationary traffic. EyeSight will prompt the driver to notice that vehicles in front have started moving again with a buzzer and a flashing indicator.

**04. LANE KEEP ASSIST**

Lane Keep Assist will offer gentle steering control if the vehicle is about to deviate from its lane at approximately 40 mph or above.

**ACCIDENT PREVENTION**

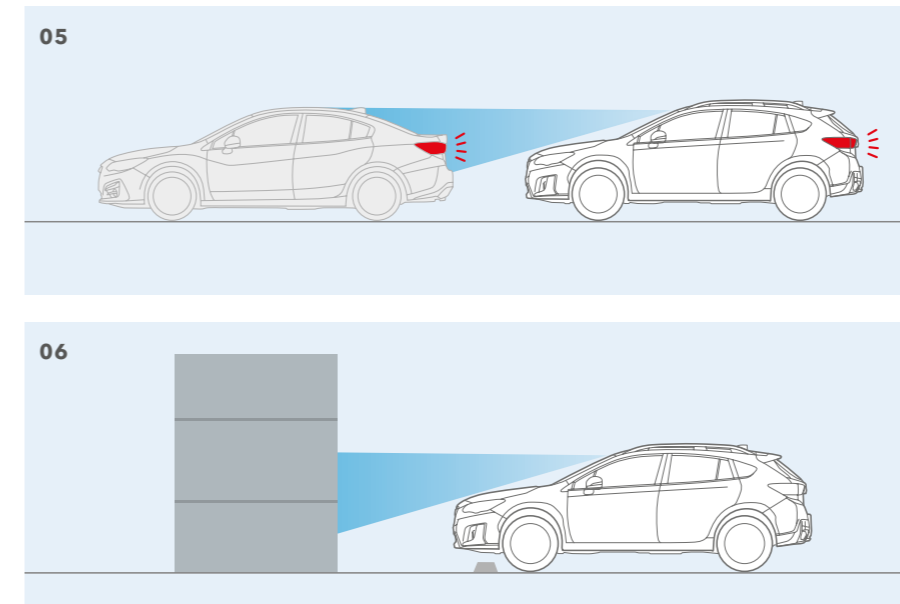

**05. PRE-COLLISION BRAKING SYSTEM**

Pre-collision Braking System activates visual and audible warnings to alert the driver of a potential collision. If the driver fails to take evasive action, the brakes will be applied automatically to either prevent an accident entirely or reduce the severity of an impact depending on speed. If the driver brakes but does not apply enough pressure, the system will increase braking force.

**06. PRE-COLLISION THROTTLE MANAGEMENT**

If the car is parked facing an obstacle, EyeSight will give the driver a visual and audible warning if they accidentally select drive instead of reverse. The system will also cut engine output to help avoid a frontal collision.

\* EyeSight is a driving support system which may not operate optimally under all driving conditions or for all objects. The driver is always responsible for safe and attentive driving and observance of traffic regulations. See Owner's Manual for complete details on system operation and limitations for EyeSight including functions in this brochure.

Field of vision range from EyeSight (not an actual measurement).

**EXTERIOR COLOURS**



CRYSTAL WHITE PEARL

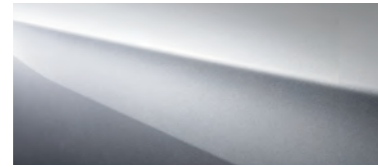

ICE SILVER METALLIC

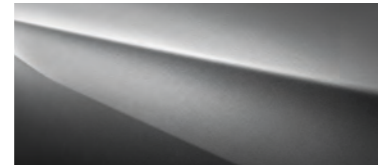

DARK GREY METALLIC



PURE RED

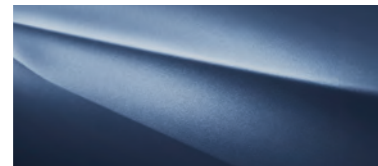

QUARTZ BLUE METALLIC



COOL GREY KHAKI\*1

**SEAT MATERIAL**

BLACK LEATHER \*2

CHARCOAL FABRIC \*3



Seat Trim

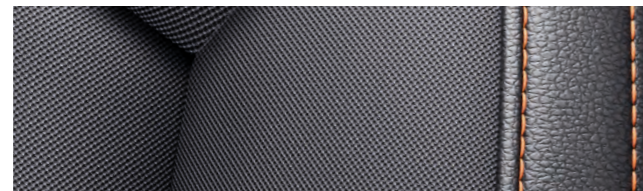

Seat Trim

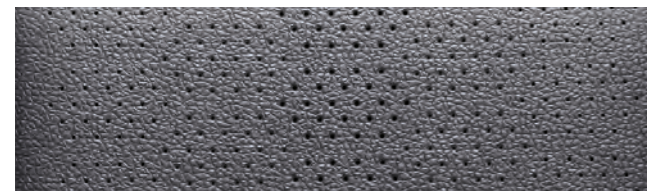

Seat Backing



Seat Backing

**01. LED Steering Responsive Headlights**

Powered by LEDs, these bi-functional headlights combine low and high beams and are steering responsive, ensuring good visibility around corners at night.



01



03

**03. Roof Rails\***

Roof rails on the XV make light work of carrying bulky loads.

**04. Rear Fog Lights**

Increase your car's visibility to vehicles behind in poor weather. Rear fog lights are installed in the bumper and protected by mouldings, adding to the stylish and powerful look of the XV.



04

**05. 17" Aluminium-alloy Wheels (1.6L only)**

Durable and lightweight, these stylish wheels show the XV's functionality and unique personality.



05



02

**02. 18" Aluminium-alloy Wheels (2.0L only)**

You'll immediately tell the SUBARU XV apart from any other vehicle by its new wheel design. These durable and lightweight wheels showcase XV's powerful, lively, and unique personality.



06

**06. Dual-zone Automatic Air-conditioning System**

The air-conditioning system distributes air efficiently for a comfortable cabin in any weather. Both driver and front passenger can independently set their preferred temperature.

**07. Keyless Entry and Push-button Start System**

With the key fob in your possession, you can unlock the front doors or boot by just gripping the handle and start the engine with a push of a button.



07



08

**08. Dual USB Ports and Auxiliary Audio Input Jack**

Keep all your electronic devices fully charged with easily-accessed USB power ports for both front and rear passengers. Connect just about any music player through the aux-in jack to play your favourite songs through the audio system.

\*1 Available on 2.0L models only.  
 \*2 Available on Premium models only.  
 \*3 Available on SE models only.

\* Requires purchase of optional accessory attachments to carry items on the longitudinal roof rails.



Pure Red

**SUBARU XV 1.6i SE Lineartronic**

DIMENSIONS: L x W x H: 4465 x 1800 x 1615 mm  
 ENGINE: Horizontally opposed, 4-cylinder, DOHC 16-valve petrol direct injection  
 CAPACITY: 1600 cc  
 MAX OUTPUT: 114 PS @ 6,200 rpm  
 MAX TORQUE: 150 Nm @ 3,600 rpm  
 TRANSMISSION: Lineartronic, AWD



Crystal White Pearl

**SUBARU XV 1.6i SE Premium Lineartronic**

DIMENSIONS: L x W x H: 4465 x 1800 x 1615 mm  
 ENGINE: Horizontally opposed, 4-cylinder, DOHC 16-valve petrol direct injection  
 CAPACITY: 1600 cc  
 MAX OUTPUT: 114 PS @ 6,200 rpm  
 MAX TORQUE: 150 Nm @ 3,600 rpm  
 TRANSMISSION: Lineartronic, AWD



Cool Grey Khaki

**SUBARU XV 2.0i SE Lineartronic**

DIMENSIONS: L x W x H: 4465 x 1800 x 1615 mm  
 ENGINE: Horizontally opposed, 4-cylinder, DOHC 16-valve petrol direct injection  
 CAPACITY: 1995 cc  
 MAX OUTPUT: 156 PS @ 3,600 rpm  
 MAX TORQUE: 196 Nm @ 4,000 rpm  
 TRANSMISSION: Lineartronic, AWD



Ice Silver Metallic

**SUBARU XV 2.0i SE Premium Lineartronic**

DIMENSIONS: L x W x H: 4465 x 1800 x 1615 mm  
 ENGINE: Horizontally opposed, 4-cylinder, DOHC 16-valve petrol direct injection  
 CAPACITY: 1995 cc  
 MAX OUTPUT: 156 PS @ 3,600 rpm  
 MAX TORQUE: 196 Nm @ 4,000 rpm  
 TRANSMISSION: Lineartronic, AWD



Whilst every SUBARU XV comes generously equipped, SUBARU accessories are the perfect way to tailor your SUBARU to your life and your style. Whether you want to add convenience, enhance functionality, or personalise your XV's appearance, SUBARU accessories are designed to provide the same fit and quality as your SUBARU vehicle. For more details, ask for the accessory brochure or visit your nearest SUBARU retailer.

PERSONALISE  
YOUR RIDE.



01. Front Grille Winglet (Black/Orange)



02

02. Front Resin Underguard

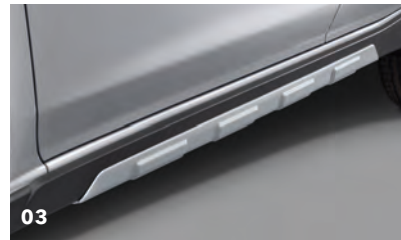

03

03. Side Resin Underguard



04

04. Rear Resin Underguard



05

05. 17" Aluminium Wheel



06

06. Carpet Mat Premium

# STANDARD FEATURES

Item	SYMMETRICAL ALL-WHEEL DRIVE (AWD)			
	1.6i SE Lineartronic	1.6i SE Premium Lineartronic	2.0i SE Lineartronic	2.0i SE Premium Lineartronic
	CVT			
<b>EXTERIOR</b>				
Automatic LED headlights	•	•	•	•
Steering responsive headlights	•	•	•	•
High beam assist	•	•	•	•
Automatic rain sensing windscreen wipers	•	•	•	•
Pop-up type headlight washers	•	•	•	•
Front fog lights	•	•	•	•
Rear fog lights	•	•	•	•
Power-folding door mirrors with built-in LED indicators	•	•	•	•
UV protection glass: windscreen, front & rear side windows	•	•	•	•
Privacy glass for rear doors, rear quarters & rear window	•	•	•	•
17" alloy wheels	•	•	-	-
18" alloy wheels	-	-	•	•
Wheel arch cladding	•	•	•	•
Sunroof - power sliding & tilt-adjustable	-	•	-	•
Roof rails	•	•	•	•
Roof spoiler	•	•	•	•
<b>SEATING &amp; TRIM</b>				
Leather wrapped steering wheel & gearshift knob	•	•	•	•
Fabric seats	•	-	•	-
Leather seats	-	•	-	•
6-Way manually adjustable driver's seat	•	-	•	-
8-Way power adjustable driver's seat	-	•	-	•
Heated front seats	•	•	•	•
60/40 Split folding rear seats	•	•	•	•
<b>COMFORT &amp; CONVENIENCE</b>				
Power windows*1	•	•	•	•
Remote control central locking	•	•	•	•
Keyless entry & push button start system	•	•	•	•
Electric parking brake	•	•	•	•
Map lights	•	•	•	•
Illuminated vanity mirrors (driver & front passenger)	•	•	•	•
Centre console box	•	•	•	•
Front cup holders (centre console)	•	•	•	•
Door pockets with bottle holders (all doors)	•	•	•	•
Fuel lid lock release	•	•	•	•
Two 12 volt power outlets (instrument panel & centre console box)	•	•	•	•
Boot hooks	•	•	•	•
Luggage hooks	•	•	•	•
Retractable parcel shelf	•	•	•	•
Boot under floor storage	•	•	•	•
Tyre repair kit	•	•	•	•
<b>CLIMATE CONTROL</b>				
Dual-zone automatic air-conditioning system with anti-dust filter	•	•	•	•
Windscreen wiper de-icer	•	•	•	•
Heated door mirrors	•	•	•	•
Heated rear window with timer	•	•	•	•

Item	SYMMETRICAL ALL-WHEEL DRIVE (AWD)			
	1.6i SE Lineartronic	1.6i SE Premium Lineartronic	2.0i SE Lineartronic	2.0i SE Premium Lineartronic
	CVT			
<b>ENTERTAINMENT</b>				
SUBARU infotainment & audio system: 1 CD & 6 speakers	•	•	•	•
8" Multi-function colour touchscreen	•	•	•	•
Apple Carplay™ and Android Auto™	•	•	•	•
DAB radio	•	•	•	•
Satellite navigation	-	•	-	•
Voice recognition system	•	•	•	•
Steering wheel mounted audio & cruise controls	•	•	•	•
Bluetooth®	•	•	•	•
Dual USB ports & auxiliary audio input jack	•	•	•	•
Reversing camera	•	•	•	•
<b>CONTROLS &amp; INSTRUMENTS</b>				
Stop & start system*2	•	•	•	•
4.3" LCD multi-information display*3	•	•	•	•
Tilt-adjustable / telescopic steering wheel	•	•	•	•
Paddle shift	-	-	•	•
Adaptive cruise control	•	•	•	•
<b>DRIVABILITY</b>				
X-MODE & hill descent control	•	•	•	•
Vehicle dynamics control system	•	•	•	•
Hill assist	•	•	•	•
<b>SAFETY &amp; SECURITY</b>				
EyeSight - includes: - Adaptive cruise control - Pre-collision braking - Pre-collision throttle management - Lane sway and departure warning - Lane keep assist - Lead vehicle start alert	•	•	•	•
SUBARU rear vehicle detection (SRVD) includes: - Blind spot monitoring - Lane change assist - Rear cross traffic alert	•	•	•	•
Front SRS*4 airbags	•	•	•	•
Front side SRS*4 airbags (driver & front passenger)	•	•	•	•
Curtain SRS*4 airbags	•	•	•	•
Knee SRS*4 airbags	•	•	•	•
Side door reinforcement beams	•	•	•	•
Steering column support beam	•	•	•	•
Rear seat headrests for 3 seating positions	•	•	•	•
Whiplash reducing front seats	•	•	•	•
Seatbelt indicator (driver & all passengers)	•	•	•	•
Height adjustable front seatbelts with pretensioners & load limiters	•	•	•	•
Rear 3-point seatbelts for 3 seating positions	•	•	•	•
Safety pedal system	•	•	•	•
ABS (anti-lock braking system) with EBFDF (electronic brake force distribution)	•	•	•	•
Brake assist system	•	•	•	•
Brake override	•	•	•	•
ISOFIX adapted child seat anchors (with tether anchors)	•	•	•	•
Child-proof rear door locking	•	•	•	•
Thatcham cat 1 alarm system & immobiliser	•	•	•	•

# SPECIFICATIONS

Item	SYMMETRICAL ALL-WHEEL DRIVE (AWD)		
	1.6i SE / 1.6i SE Premium		2.0i SE / 2.0i SE Premium
	Lineartronic		Lineartronic
<b>ENGINE</b>			
Type	Horizontally-opposed, 4-cylinder, 4-stroke, petrol engine		
Valve train	DOHC 16-valve		
Bore/Stroke	mm	78.8 x 82	84 x 90
Capacity	cc	1,600	1,995
Compression ratio		11.0	12.5
Fuel system		Port fuel Injection	Direct fuel Injection
Fuel tank capacity (approx.)	lit.	63	
<b>PERFORMANCE</b>			
Net Power	PS @ rpm	114 @ 6,200	156 @ 3,600
Torque	Nm @ rpm	150 @ 3,600	196 @ 4,000
Max. speed	mph	109	120
Acceleration (0-62 mph)	sec.	13.9	10.4
Fuel consumption*5	Urban	mpg	35.8
	Extra-urban	mpg	50.4
	Combined	mpg	44.1
CO <sub>2</sub> emissions*5	g/km	145	155
<b>DRIVETRAIN</b>			
All-Wheel Drive type	Active Torque Split AWD system		
<b>DIMENSIONS &amp; WEIGHT</b>			
Overall length	mm	4,465	
Overall width	mm	1,800	
Overall height	mm	1,615	
Wheelbase	mm	2,665	
Track	Front	mm	1,550
	Rear	mm	1,555
Ground clearance (at kerb weight)	mm	220	
Boot volume	lit.	385	
Seating capacity	persons	5	
Kerb weight	kg	1,408	1,439
Towing capacity	kg	1,400	
<b>TRANSMISSION</b>			
Gear ratio	D range (Lineartronic)		3.601 ~ 0.513
	Reverse		3.687
Final drive axle ratio		4.111	3.900
<b>CHASSIS</b>			
Steering	Pinion-assist type electric power steering		
Suspension (4-wheel independent)	Front	MacPherson strut type	
	Rear	Double wishbone type	
Brakes	Front	Ventilated disc brakes	
	Rear	Disc brakes	
Tyre/wheel size		225/60R17, 17 x 7" J	225/55R18, 18 x 7" J

MPG figures are official EU test figures for comparative purposes and may not reflect real driving results.

\*1 Driver's window has auto up/down function with pinch protection.

\*2 The Stop & Start system will automatically stop and restart the engine when the car comes to a standstill to reduce fuel consumption and emissions.

\*3 Displays: fuel economy screen, eco-evaluation screen, driving condition, clock with outside temperature and maintenance information etc.

\*4 SRS: Supplemental Restraint System. Must be used in conjunction with seatbelts.

\*5 Fuel consumption and CO<sub>2</sub> emissions: according to EC 715/2007 - 459/2012 ZD.





## DISCOVER SUBARU

Like to arrange a test drive? After the latest on the SUBARU XV or other SUBARU models? Looking for your nearest SUBARU showroom? Simply get in touch...



**SUBARU**

*Confidence in Motion*



Visit the SUBARU UK website for the latest information about the SUBARU range.

[subaru.co.uk](http://subaru.co.uk)

Visit the SUBARU UK website for the latest information about the SUBARU range.

[youtube.com/officialsubaruuk](http://youtube.com/officialsubaruuk)



Stay connected with the SUBARU UK community and be the first to hear the latest news directly from SUBARU.

[facebook.com/OfficialSubaruUK](https://facebook.com/OfficialSubaruUK) [twitter.com/subaruuk](https://twitter.com/subaruuk)

## DIMENSIONS

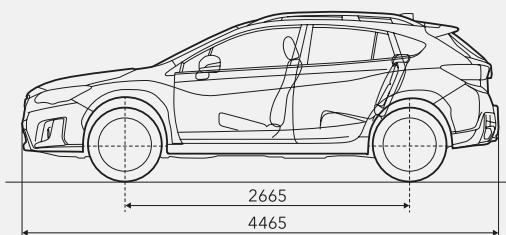
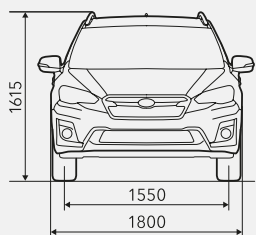

Dimensions are measured in accordance with standard measurement of SUBARU CORPORATION.

SUBARU CORPORATION reserves the right to alter specifications and equipment without notice. Details of specifications, equipment, colour availability and the accessory lineup are subject to suit local conditions and requirements. Please enquire at your local retailer for details of any changes that might be required for your area.

Not all features, options, or packages are available for all models and regions. See your specification sheet for availability. Please contact your local authorised SUBARU retailer for more details.



†The service intervals for the SUBARU XV are every 12 months / 12,000 miles, whichever comes sooner. The SUBARU XV is covered by a 5 Year / 100,000 miles (whichever is sooner) Limited Warranty. This comprises of a standard 3 Year / 60,000 miles (whichever is sooner) Manufacturer's Warranty (bumper to bumper, excluding clutch driven plate) and an Extended Warranty that applies to the powertrain only, provided by the importer, to complete the 5 Year / 100,000 miles (whichever is sooner) Limited Warranty. All vehicle bodywork is covered by a 12 Year Anti-Corrosion Warranty and paintwork is covered by a 3 Year / 60,000 miles (whichever is sooner) Warranty. Added reassurance is provided by a comprehensive 3 Year Recovery and Assistance Programme valid in the UK only. For general terms and conditions visit [SUBARU.co.uk](http://SUBARU.co.uk).

Technical data and equipment based on the latest information available at the time of printing. SUBARU (UK) Ltd reserves the right to make changes at any time, without notice, in colours, materials, design, prices, equipment and specifications and to discontinue models. Customers are advised to consult their SUBARU dealer on the precise details of warranties / guarantees and vehicles available for sale. Models specified are strictly subject to availability. Owing to the limitations of printing processes, the colours reproduced may not exactly match product colours. The contents of this brochure are the copyright of SUBARU (UK) Ltd and may not be copied or displayed for commercial purposes without the express permission of SUBARU (UK) Ltd. © SUBARU (UK) Ltd. E & O.E.

SUBARU (UK) Ltd.

For details of your nearest SUBARU dealer phone 03303 335117 or visit [SUBARU.co.uk](http://SUBARU.co.uk).

Calls (to 03 numbers) cost no more than calls to geographic numbers (01 or 02) and must be included in inclusive minutes and discount schemes in the same way. Calls from landlines are typically charged up to 9p per minute; calls from mobiles typically cost between 3p and 40p per minute. Calls from landlines and mobiles are included in free call packages.

**5** YEAR  
WARRANTY†

18MY SXV016